

# Woodbridge Fireplace Inc.



## OUTDOOR FIRE FEATURE IN ENCLOSURE

### OWNER'S OPERATION AND INSTALLATION MANUAL









We recommend that our products be installed and serviced by professionals who are certified in the U.S. by NFI (National Fireplace Institute).



Report # 0401GF002S

Complies with ANS Z21.97.CSA 2.41-2017 "Outdoor Decorative Gas Appliances",  
CSA 2.17-2017 "Gas-Fired Appliances for Use at High Altitudes"

 <b>DANGER</b> 	<b>CARBON MONOXIDE HAZARD</b> This appliance can produce carbon monoxide which has no odor. Using it in an enclosed space can kill you. Never use this appliance in an enclosed space as a camper, tent, car or home.	 <b>WARNING</b> Improper installation, adjustment, alteration, service, or maintenance can cause injury or property damage. Read the installation, operating and maintenance instructions thoroughly before installing or servicing this equipment.
 <b>DANGER</b> If you smell gas: 1. Shut off gas to appliance. 2. Extinguish any open flame. 3. If odor continues, keep away from the appliance and immediately call your gas supplier or fire department.		 <b>WARNING</b> Do not store or use gasoline or other flammable vapors and liquids in the vicinity of this or any other appliance. A propane cylinder not connected for use shall not be stored in the vicinity of this or any other appliance.
 <b>WARNING: For Outdoor Use Only</b>		

**INSTALLER:** Leave this manual with the appliance. **CONSUMER:** Retain this manual for future reference.

Version française de ce manuel est disponible à partir du site WEB : [www.woodbridgedealer.com](http://www.woodbridgedealer.com)  
French version of this Owners Manual is available at [www.woodbridgedealer.com](http://www.woodbridgedealer.com)

## SAFETY INFORMATION



### WARNINGS

**IMPORTANT:** The appliance should be inspected before use and at least annually by a qualified service person. More frequent cleaning may be required as necessary. It is imperative that the control compartment, burners and circulating air passageways of the appliance be kept clean.

**⚠ DANGER:** Carbon monoxide poisoning may lead to death!

**Carbon Monoxide Poisoning:** Early signs of carbon monoxide poisoning resemble the flu, with headaches, dizziness, or nausea. If you have these signs, the Fireplace may not be working properly. **Get fresh air at once!** Have the Fireplace serviced. Some people are more affected by carbon monoxide than others. These include pregnant women, people with heart or lung disease or anemia, those under the influence of alcohol, and those at high altitudes.

**Natural Gas:** Natural gas is odorless. An odor making agent is added to the gas. The odor helps you detect a gas leak. However, the odor added to the gas can fade. Gas may be present even though no odor exists. Make certain you read and understand all warnings. Keep this manual for reference. It is your guide to safe and proper operation of this appliance.

**⚠ WARNING:** Any change to this appliance or its controls can be dangerous.

1. This appliance, as supplied, is only for use with the type of gas indicated on the rating plate.
2. When an appliance is for connection to a fixed piping system, the installation must conform with local codes, or in the absence of local codes with the *National Fuel Gas Code, ANSI Z223.1/NFPA 54, or International Fuel Gas Code, Natural Gas and Propane Installation Code, CSA B149.1, or Propane Storage and Handling Code, B149.2, as applicable.*
3. Keep the appliance area clear and free from combustible materials, gasoline and other flammable vapors and liquids.
4. Do not burn solid fuel in the fireplace after installing the appliance. Do not use this appliance to cook food or burn paper or other objects.
5. **Children and adults should be alerted to the hazards of high surface temperatures and should stay away to avoid burns or clothing ignition.**
6. **Clothing or other flammable materials should not be hung from the appliance, or placed on or near the appliance.**
7. **Young children should be carefully supervised when they are in the area of the appliance.**
8. The appliance, when installed, must be electrically grounded in accordance with local codes or, in the absence of local codes, with the *National Electrical Code, ANSI/NFPA 70 or the Canadian Electrical Code, CSA C22.1, if applicable.*
9. **Do not use appliance if any part has been under water. Immediately call a qualified service technician to inspect the room appliance and to replace any part of the control system and any gas control which has been under water.**
10. Inspect the burner before each use of Outdoor Fire Feature. The burner must be replaced prior to the appliance being put into operation if it is evident that the burner is damaged. Please refer to "*Illustrated parts List*" for the replacement burner part number.
11. Turn the appliance off and let cool before servicing, installing, or repairing. **Any guard or other protective device removed for servicing the appliance must be replaced prior to operating the appliance.** Only a qualified service person should install, service, or repair appliance.

### HIGH ALTITUDE INSTALLATIONS:

The appliance is rated for installations up to 4500' (1372 m) above sea level. Above 4500' the appliance must be de-rated at the factory for the appropriate altitude.

### LOCAL CODES

Install and use Outdoor Fireplace with care. Follow local codes. In the absence of local codes, use the latest edition of *The National Fuel Gas Code ANSI Z223.1/NFPA 54* available from:

- \* American National Standards Institute, Inc., 1430 Broadway, New York, NY 10018
- \* National Fire Protection Association, Inc., Batterymarch Park, Quincy, MA 02269.

## LOCATING YOUR OUTDOOR GAS FIREPLACE

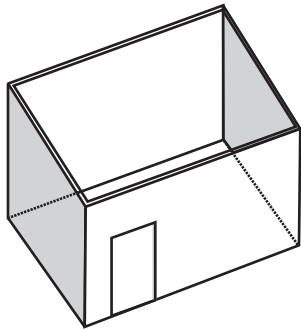

- 1) When selecting a location for your fireplace, ensure that the clearances are met.
- 2) This appliance must be installed in an open-air situation with natural ventilation, without stagnant areas, where gas leakage and products of combustion are rapidly dispersed by wind and natural convection.
- 3) Certain materials or items, when placed under or near the appliance, will be subjected to radiant heat and could become damaged.
- 4) Typically an outdoor space is not enclosed but, any enclosure in which the appliance is used shall comply with one of the following:

An enclosure with walls on all sides, but at least one permanent opening at ground level and no overhead cover.

Within a partial enclosure that includes an overhead cover and no more than two walls.

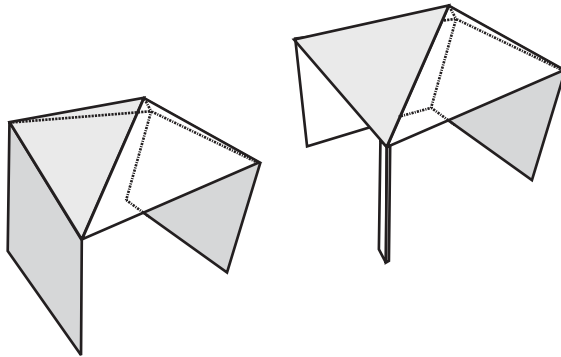

Within a partial enclosure that includes an overhead cover and more than two walls, the following shall apply:

- At least 25% of the total wall area is completely open, and
- At least 30% of the remaining wall area is open and unrestricted

30% or more in total of the remaining wall area is open and unrestricted.

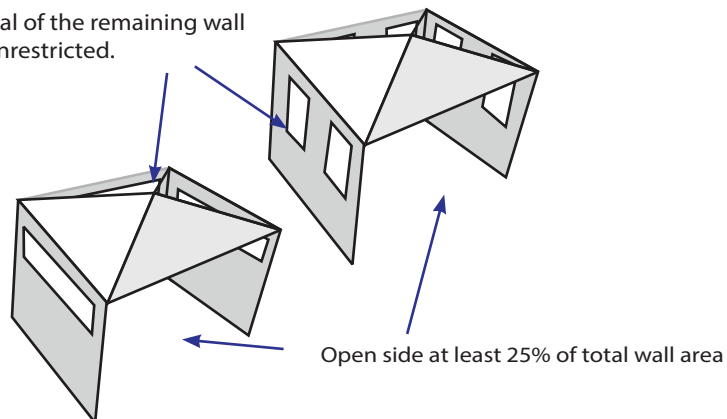

**IMPORTANT:** Minimum ambient air temperature for the fireplace operation is 0°C (32°F)

## PRODUCT ASSEMBLY

**WARNING:** Failure to position the parts in accordance with these diagrams or failure to use only parts specially approved with this appliance may result in property damage or personal injury.

1. Remove Burner Assembly, Front Cover and Burner Media from packaging (see *Parts List*, page 14).
2. Connect the Burner Assembly to gas supply using supplied flex connector and shutoff valve.
3. Evenly fill the media compartment with burner media (broken tempered glass) fully covering the burner as shown on a picture.



If you are NOT planning to add optional topping media, then fill the media compartment in full and proceed to the step 5.

**NOTE:** If you are planning to add some topping media (optional colored glass or lava rock), leave approximately 3/4" not filled on top of burner media and proceed to the next step.

4. Place and evenly distribute topping media (optional

colored glass or lava rock) on top of burner media as shown on a picture.



Make sure that pilot opening is not blocked with excess of media.

5. Carefully leak test all connections following the procedure on page 5.
6. Having free access to the valve and manifold compartment of the Burner Assembly turn ON the appliance following the procedure on page 8. *Make sure the flame is even along the burner and appliance is fully operational and safe for use. Turn OFF the appliance and let it cool before proceeding to the next step.*
7. Cover manifold and valve compartment of the Burner Assembly with Front Cover. Install the Rear Tray on opposite side from the burner.
8. Fill the trays with topping media to desired level.



## INSTALLATION

**CAUTION:** Do not remove the metal data plates attached to the Fire Feature. These plates contain important information.

**NOTICE:** Installation and repair should be done by a qualified service person. The appliance should be inspected before use and at least annually by a qualified service person. More frequent cleaning may be required as necessary. It is imperative that control compartment, burner and circulating air passageways of the appliance be kept clean.

**WARNING:** Never light the appliance without having the clear glass media completely covering the burner!

### CLEARANCES TO COMBUSTIBLE MATERIALS FROM THE BURNER:

- Top..... 60" (153 cm)
- Short Side of the Unit to Wall ..... 8" (21 cm)
- Long Side of the Unit to Wall ..... 16" (41 cm)

No Thermal Floor Protection Required

### Fuel pressure specification:

Inlet Nat. Gas (NG)	Min: 4.5" w.c.
	Max: 10.5" w.c.
Manifold (NG)	3.5" w.c.
Inlet Propane	Min: 11.0" w.c.
	Max: 13.0" w.c.
Manifold	10.0" w.c.

## Fire Feature Enclosure Dimensions

TOP VIEW

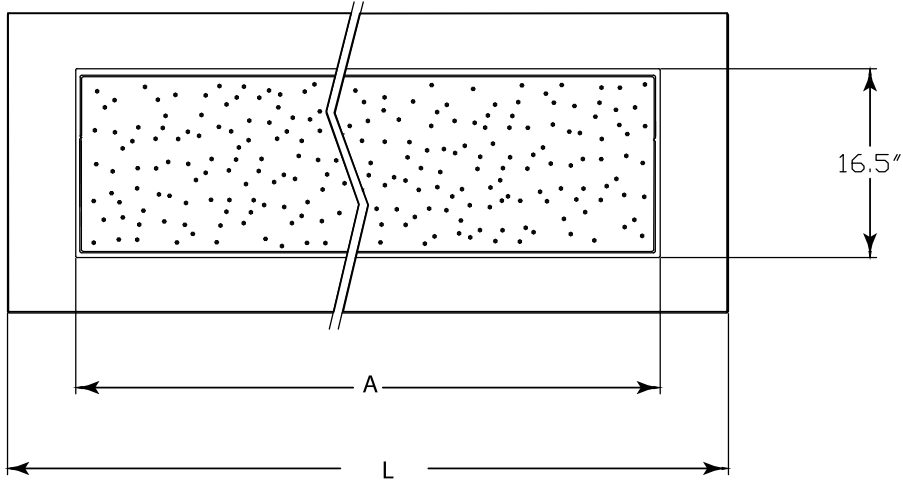

Model	L	A	B
FF24-ENC	36.125"	24.75"	29.75"
FF36-ENC	48.125"	36.75"	41.75"
FF48-ENC	60.125"	48.75"	53.75"
FF60-ENC	72.125"	60.75"	65.75"
FF72-ENC	84.125"	72.75"	77.75"
FF84-ENC	96.125"	84.75"	89.75"
FF96-ENC	108.125"	96.75"	101.75"

**NOTE:** Fire Feature with Enclosure can be installed on any non-combustible materials.

Cover (see Illustrated Parts List, page 15) must be in place when appliance is not in use.

SIDE VIEW

FRONT VIEW

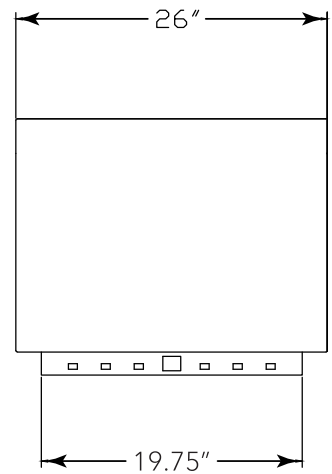
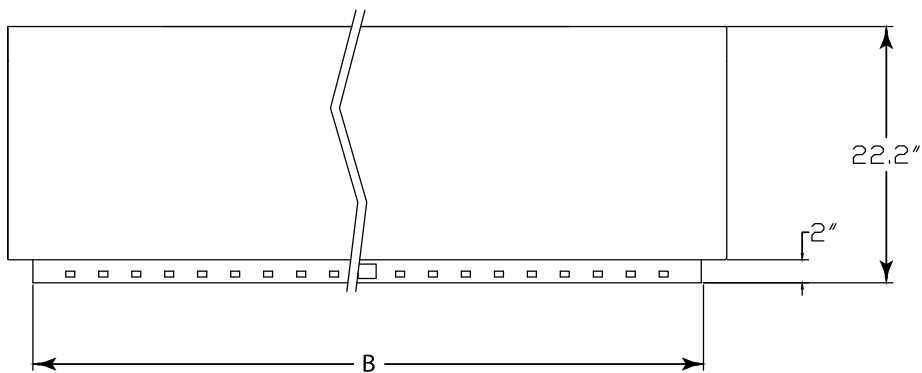

# FIREPLACE INSTALLATION

## CHECK GAS TYPE

Use proper gas type for the fireplace you are installing. If you have conflicting gas type, do not install fireplace. See dealer where you purchased the fireplace for proper fireplace for your gas type or conversion kit.

## INSTALLING GAS PIPING TO FIREPLACE / FIRE FEATURE LOCATION

### WARNING

A qualified installer or service person must connect appliance to gas supply. Follow all local codes.

### CAUTION

For propane units, never connect fireplace directly to the propane supply. This Fire Feature requires an external regulator (not supplied). Install the external regulator between the Fire Feature and propane supply.

## INSTALLATION ITEMS NEEDED

Before installing fireplace/Fire Feature, make sure you have the items listed below.

- External regulator (supplied by installer)
- Equipment shutoff valve\*
- Tee joint
- approved flexible gas line with gas connector (if allowed by local codes — not provided)
- Piping (check local codes)
- Test gauge connection\*
- Pipe wrench
- Sealant (resistant to propane)
- Sediment trap (recommended)

\* A CSA design-certified equipment shutoff valve with  $\frac{1}{8}$ " NPT tap is an acceptable alternative to test gauge connection. Purchase the CSA design-certified equipment shutoff valve from your dealer.

For propane connections only, the installer must supply an external regulator. The external regulator will reduce incoming gas pressure. You must reduce incoming gas pressure to between 11 and 13 inches of water. If you do not reduce incoming gas pressure, Fire Feature regulator damage could occur. Install external regulator with the vent pointing down as shown in *Figure 1*. Pointing the vent down protects it from freezing rain or sleet.

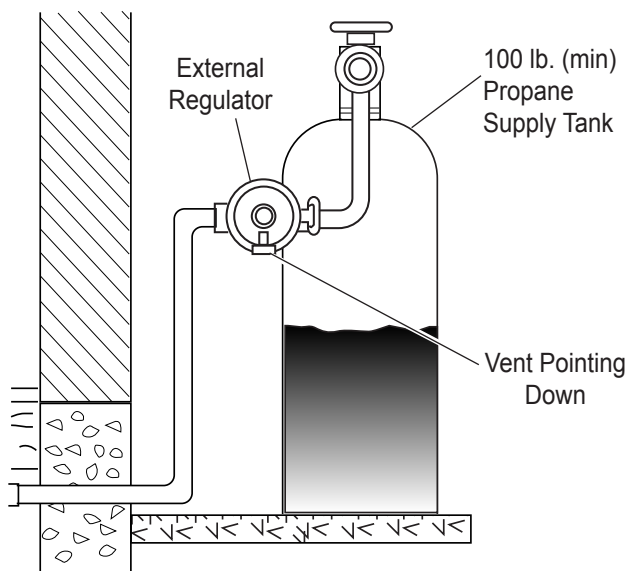

**Figure 1 - External Regulator with Vent Pointing Down (Propane Only)**

### CAUTION

Use only new black iron or steel pipe. Internally tinned copper or copper tubing can be used per National Fuel Code, section 2.6.3, providing gas meets hydrogen sulfide limits, and where permitted by local codes. Gas piping system must be sized to provide minimum inlet pressure (listed on data plate) at the maximum flow rate (BTU/hr). Undue pressure loss will occur if the pipe is too small.

When using copper or flex connectors use only fittings approved for gas connections. The gas control inlet is  $\frac{3}{8}$ " NPT.

## CONNECTING TO GAS SUPPLY

**⚠ WARNING: A qualified service person must connect appliance to gas supply. Follow all local codes.**

### Installation Items Needed

Before installing the Outdoor Fireplace, make sure you have all items listed below:

- piping (check local codes)
- sealant
- manual shutoff valve
- adjustable (crescent) wrench or pliers
- sediment trap
- tee joints
- pipe wrench

**⚠ CAUTION: Use only new, black iron or steel pipe. Internally tinned copper tubing may be used in certain areas. Use pipe of 1/2" diameter or greater to allow proper gas volume to Fire Feature. If pipe is too small, undue loss of pressure will occur.**

Installation must include a manual shutoff valve, union, and plugged 1/8" NPT tap. Locate NPT tap within reach for test gauge hook up. NPT tap must be upstream from the appliance.

Apply pipe joint sealant lightly to male threads. This will prevent excess sealant from going into pipe. Excess sealant in pipe could result in a clogged burner injector.

Install sediment trap in supply line as shown below. Locate sediment trap where it is within reach for cleaning and trapped matter is not likely to freeze. A sediment trap

traps moisture and contaminants. This keeps them from going into Outdoor Fireplace controls.

If sediment trap is not installed or is installed wrong, unit may not run properly.

## CHECKING GAS CONNECTION

**⚠ WARNING: Test all gas piping and connections for leaks after installing or servicing. Correct all leaks at once.**

**⚠ WARNING: Never use an open flame to check for a leak. Apply a mixture of liquid soap and water on all joints. Bubbles forming show a leak. Correct all leaks at once.**

### Test Pressures in Excess Of 1/2 psi (3.5 kPa)

The appliance and its individual shutoff valve must be disconnected from the gas supply piping system during any pressure testing of that system at test pressures in excess of 1/2 psi (3.5 kPa).

### Test Pressures Equal To or Less Than 1/2 psi (3.5 kPa)

The appliance must be isolated from the gas supply piping system by closing its individual manual shutoff valve during any pressure testing of the gas supply piping system at test pressures equal to or less than 1/2 psi (3.5 kPa).

## IMPORTANT

**This appliance is not designed for use with a non-disposable, self-contained propane supply system! Do not use a gas hose to connect the appliance to any gas supply. Use approved Flexible Gas Connectors.**

Approved Flexible Gas Connector

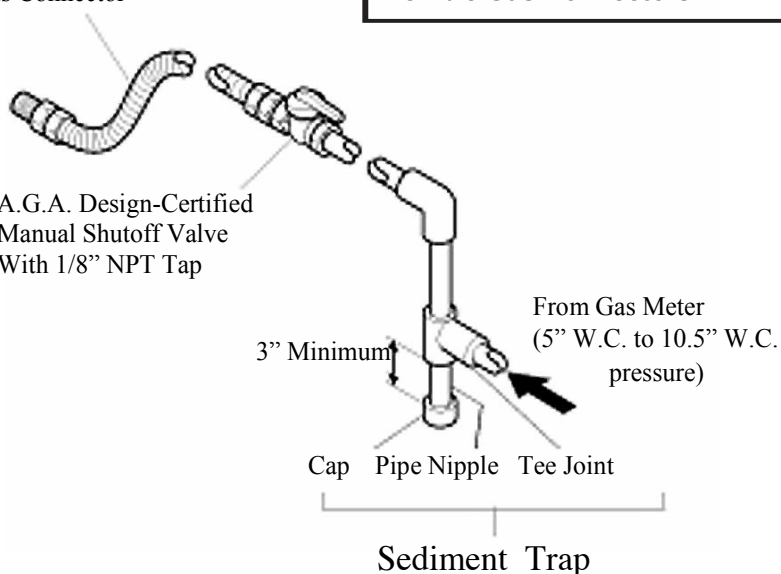

# FIRE FEATURE SPECIFICATIONS

## BURNER DIMENSIONS

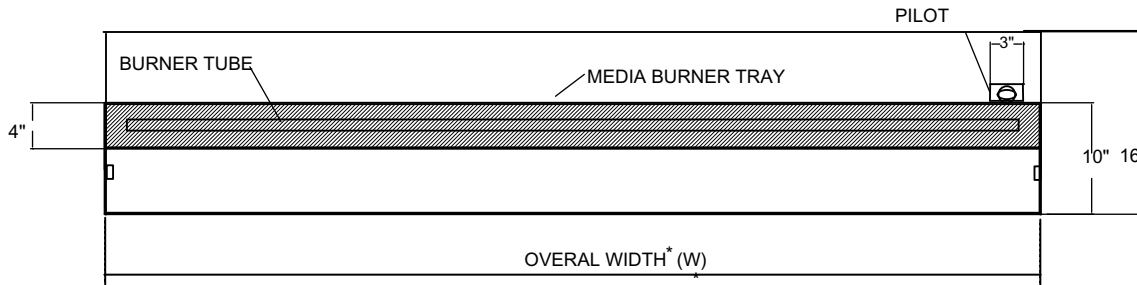
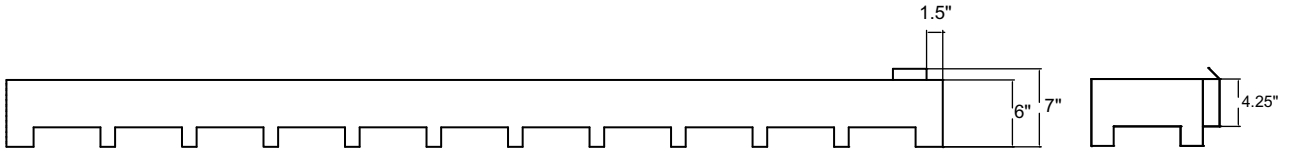

## TOP COVER DIMENSIONS

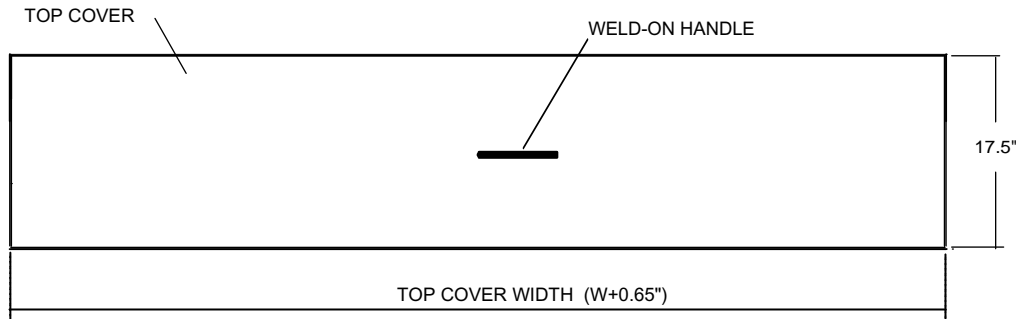
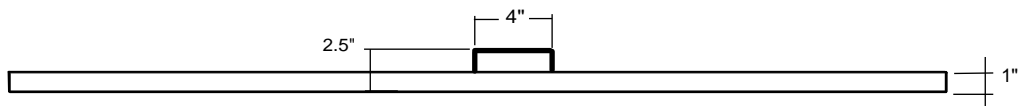

MODEL	OVERALL WIDTH (W)	BURNER TUBE LENGTH	INPUT RATE (Btu/hr)		# ORIF. N.G. (Prop)	ORIF. SIZE	
			N.G.	Propane		N.G.	Prop
FF24 - N (P)	24"	20"	41,000	33,500	2 (1)	44	49
FF36 - N (P)	36"	32"	61,000	54,000	3 (1)	44	43
FF48 - N (P)	48"	44"	82,000	72,000	4 (1)	43	38
FF60 - N (P)	60"	56"	102,000	90,000	5 (2)	43	46
FF72 - N (P)	72"	68"	116,000	110,000	6 (2)	43	41
FF84 - N (P)	84"	80"	129,000	128,000	7 (2)	43	38
FF96 - N (P)	96"	92"	142,000	146,500	8 (2)	43	35



# LIGHTING INSTRUCTION

## FOR YOUR SAFETY READ BEFORE OPERATING

### WARNING

If you do not follow these instruction exactly, a fire or explosion may result causing property damage, personal injury or loss of life.

- A. This appliance is equipped with an ignition device which automatically lights the pilot. Do not try to light the pilot by hand.
- B. BEFORE OPERATING smell all around the appliance area for gas. Be sure to smell next to the floor because some gas is heavier than air and will settle on the floor.

### WHAT TO DO IF YOU SMELL GAS:

- Do not try to light any appliance.
  - Do not touch any electric switch; do not use any phone in your building.
  - Immediately call your gas supplier from a neighbor's phone.  
Follow the gas supplier's instructions.
  - If you cannot reach your gas supplier, call the fire department.
- C. Main gas valve in this appliance is not serviceable and does not have any control knobs or switches to operate. Do not remove heat shields covering the valve and electronic devices; do not try to repair or modify the valve as it may result in a fire or explosion. Call a qualified service technician if you have any safety concerns.
- D. Do not use this appliance if any part of it has been under water. Immediately call a qualified service technician to inspect the appliance and to replace any part of the control system and any gas control that has been under water.

## LIGHTING FOR THE FIRST TIME

### INITIAL LIGHTING

Purge air from the supply line as follows:

- Open main shutoff valve.
- Unscrew main pressure test point.
- Leave inlet test screw open until gas comes in.
- When gas is flowing, tighten inlet screw immediately.

### DANGER

Never use an open flame to check for gas leak.

### LEAK TESTING

1. Follow the pipe from the gas supply line connection to the gas valve. Check connection for leaks with soap and water mixture.
2. Next check for gas leaks at the burner with soap and water mixture.
3. Check the pilot for gas leaks with soap and water mixture.

## LIGHTING FOR THE FIRST TIME

### APPROVED LEAK TESTING METHOD

You may check for gas leaks with the following methods only:

- Soap and water solution
- An approved leak testing spray
- Electronic sniffer

### DANGER

Never use an open flame to check for gas leak.

### WARNING

If using a soap and water solution to test for leaks, DO NOT spray solution onto electronic parts.

**NOTE:** Remove any excessive pipe compound from the connections. Excessive pipe compound can set off electronic sniffers.

Check for gas leaks in each of the following locations:

- Pipe from the gas supply line connection to the gas valve
- Burner connections, pilot
- All joints on valve and control body
- Field made joints / gas shutoff valve
- Factory made joints, each joint and connection

## OPERATING INSTRUCTIONS

1. **STOP! Read the safety information on previous page.**
2. Turn off all electric power to the appliance.
3. Do not attempt to light the pilot by hand.
4. Remove Front Tray from the appliance (*see Illustrated Parts List, page 14*).
5. Turn the gas control manual valve to the full OFF position.
6. Wait five (5) minutes to clear out any gas. Then smell for gas, including near the floor.  
**If you smell gas, STOP! Follow "B" in the safety information (see page 7).**  
**If you don't smell gas, go to the next step.**
7. Turn the gas control manual valve to the ON position.
8. Plug supplied 7V DC adapter into 110V power outlet.
9. Connect the wire to the DC input plug at the unit.
10. Lift and remove Heat Shield covering electronic components inside of the unit (*see Illustrated Parts List, page 13*).
11. Locate Remote Receiver inside of the unit (*see Illustrated Parts List, page 13*). Make sure that the slider switch of the Receiver is in "REMOTE" (middle) position.
12. Replace Heat Shield and then replace Front Tray.
13. Read and follow instructions in how to set up and to use remote control described in supplied "INSTALLATION AND OPERATING INSTRUCTIONS FOR SKYTECH MODEL: 1001 T/LCD-A".
14. If the appliance will not operate, follow the instructions "To Turn Off Gas To Appliance" and call your service technician or gas supplier.

## TO TURN OFF GAS TO APPLIANCE

1. Turn off all electric power to the appliance if service is to be performed.  
Unplug 7V DC adapter from the power outlet.
2. If necessary, remove Front Tray from the appliance to access manual shutoff valve on gas line.
3. Turn the gas control manual valve to the full OFF position.
4. If necessary, replace Front Tray.

### ELECTRICAL WIRING

This fireplace requires 110V AC electrical supply for normal operation in order to power up 7V DC adapter which is required to operate Remote Control. However, during power outage situation, its electronic system (DFC board) can be temporarily powered with 6V DC battery pack (4 AA batteries).

#### **WARNING**

Electrical connections should only be performed by a qualified, licensed electrician. Main power must be off when connecting to main electrical power supply or performing service. All wiring shall be in compliance with all local, city, and state codes. The appliance, when installed, must be electrically grounded in accordance with local codes, or in the absence of local codes, with the *National Electrical Code ANSI/ NFPA 70 (latest edition)* and *Canadian Electrical Code, CSA C22.1*.

#### **CAUTION**

Label all wires before disconnecting when servicing controls. Wiring errors can cause improper and dangerous operation.

#### **WARNING**

Do not operate the appliance without the burner being completely filled with glass media. Lighting the burner without the glass media will cause unsafe temperatures within the appliance.

## CLEANING AND MAINTENANCE

### WARNING

Turn off gas before servicing fireplace. It is recommended that a qualified service technician perform these check-ups at the beginning of each heating season.

### BURNER, PILOT AND CONTROL COMPARTMENT

Keep the control compartment clean by vacuuming or brushing at least twice a year. Make sure the burner porting, pilot air opening and burner air opening are free of obstructions at all times.

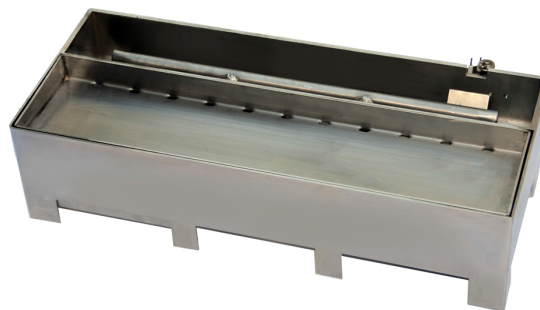

### PILOT FLAME

The flames from the pilot should be visually checked as soon as the unit is installed and periodically during normal operation. The pilot flame must always be present when the fireplace is in operation or connected to the gas line with main shutoff valve open and the IPS activated (powered). The pilot flame has two distinct flames, one engulfing the flame sensor and the other reaching to the main burner.

Pilot Flame



### BURNER

The flame from the burner should be visually checked as soon as the unit is installed and periodically during normal operation.

Keep the appliance and its burner clean by vacuuming or brushing at least twice a year. Make sure the burner porting and burner air openings are free of obstructions at all times.

Inspect area around the burner. Remove any lint or foreign material with a brush or vacuum.

The burner must be replaced prior to the appliance being put into operation if it is evident that the burner is damaged. Please refer to "Illustrated Parts List" for the replacement part number specified by the manufacturer.



## TROUBLESHOOTING

**⚠ WARNING: Turn off the unit and let cool before servicing. Only a qualified service person should service and repair this appliance.**

*Note:* All troubleshooting items are listed in order of operation.

OBSERVED PROBLEM	POSSIBLE CAUSE	REMEDY
Unit is smoking / sooting excessively <i>(Note: It is natural and unavoidable for appliance sets to produce moderate levels of carbon (soot) where flames contact the media. This is especially true with propane gas.)</i>	<ol style="list-style-type: none"> <li>1. Poor fuel quality</li> <li>2. Fireplace venting system not drafting properly</li> <li>3. Excessive flame impingement or blockage</li> <li>4. Improper fuel/air mixture</li> <li>5. Not enough media over burner tube.</li> </ol>	<ol style="list-style-type: none"> <li>1. Contact local natural or propane gas company</li> <li>2. Adjust damper wide open and/or have fireplace and venting professionally cleaned and checked</li> <li>3. Separate the stones to allow more flame passage</li> <li>4. Remove any foreign items from the flame pattern and/or check for proper orifice sizing</li> <li>5. Make sure burner tube is completely covered with glass media.</li> </ol>
Burner is excessively noisy <i>(Note: The movement and combustion of gas will create low, unavoidable levels of noise.)</i>	<ol style="list-style-type: none"> <li>1. Passage of air/gas across irregular surfaces</li> <li>2. Excessive gas pressure on natural gas units</li> </ol>	<ol style="list-style-type: none"> <li>1. Relieve any tight bends or kinks in gas supply line</li> <li>2. Check/reset gas regulator pressure</li> </ol>
Burner flame is too low or too high	<ol style="list-style-type: none"> <li>1. Incorrect gas supply or pressure</li> <li>2. Blocked burner orifice or burner manifold ports</li> <li>3. Improper burner orifice size</li> </ol>	<ol style="list-style-type: none"> <li>1. Check for proper gas supply pressure</li> <li>2. Free burner orifice and manifold ports of any burrs, paint, or other blockage i.e. spider webs, etc.</li> <li>3. Verify proper burner orifice sizing (see page 8)</li> </ol>
Remote does not function	<ol style="list-style-type: none"> <li>1. Battery is not installed. Battery power is low</li> </ol>	<ol style="list-style-type: none"> <li>1. Replace batteries in receiver and remote control. Re-program the receiver.</li> </ol>

OBSERVED PROBLEM	POSSIBLE CAUSE	REMEDY
When remote control / switch is pressed, there is spark at pilot but no ignition	<ol style="list-style-type: none"> <li>1. Gas supply turned off or manual shutoff valve closed</li> <li>2. Air in gas lines when installed</li> <li>3. Pilot adjustment screw closed</li> <li>4. Pilot is clogged</li> <li>5. Ignitor electrode broken</li> </ol>	<ol style="list-style-type: none"> <li>1. Turn on gas supply or open manual shutoff valve</li> <li>2. Purge air from the supply line (see page :)</li> <li>3. Adjust pilot flame for approximately 1" blue flame</li> <li>4. Clean pilot (see <i>Cleaning and Maintenance, page 13</i>) or replace pilot assembly.</li> <li>5. Replace pilot assembly.</li> </ol>
Burner does not light after pilot is lit	<ol style="list-style-type: none"> <li>1. Burner orifice clogged</li> <li>2. Inlet gas pressure is too low</li> <li>3. Burner orifice diameter is too small</li> <li>4. Flame sensor leads disconnected.</li> <li>5. DFC Module failure.</li> </ol>	<ol style="list-style-type: none"> <li>1. Clean burner orifice</li> <li>2. Contact local natural or propane gas company to check pressures and gas pipe sizing.</li> <li>3. Replace burner orifice(s).</li> <li>4. Reconnect leads.</li> <li>5. Replace DFC module.</li> </ol>
Delayed ignition burner	<ol style="list-style-type: none"> <li>1. Pilot flame needs adjusting</li> </ol>	<ol style="list-style-type: none"> <li>1. Adjust pilot flame for approximately 1" blue flame</li> </ol>
<div style="border: 1px solid black; padding: 5px;"> <p><b>⚠ WARNING: If you smell gas</b></p> <ul style="list-style-type: none"> <li>• Shut off gas supply.</li> <li>• Do not try to light any appliance.</li> <li>• Do not touch any electrical switch; do not use any phone in your building.</li> <li>• Immediately call your gas supplier from a neighbor's phone. Follow the gas supplier's instructions.</li> <li>• If you cannot reach your gas supplier, call the fire department.</li> </ul> </div>		
<p><b>IMPORTANT:</b> Operating unit where impurities in air exist may create odors. Cleaning supplies, paint, paint remover, cigarette smoke, cements and glues, new carpet or textiles, etc., create fumes. These fumes may mix with combustion air and create odors. These odors will disappear over time.</p>		
Unit produces unwanted odors	<ol style="list-style-type: none"> <li>1. Unit burning vapors from paint, hair spray, glues, cleaners, chemicals, new carpet, etc. (See statement above).</li> <li>2. Gas leak. <b>See Warning statement above.</b></li> </ol>	<ol style="list-style-type: none"> <li>1. Open flue to maximum. Stop using odor causing products while unit is running</li> <li>2. Locate and correct all leaks (see <i>Checking Gas Connections, page 7</i>)</li> </ol>
Gas odor even when Remote Control is in OFF position	<ol style="list-style-type: none"> <li>1. Gas leak. <b>See Warning statement above.</b></li> <li>2. Main gas valve defective</li> </ol>	<ol style="list-style-type: none"> <li>1. Locate and correct all leaks (see p.7)</li> <li>2. Replace gas valve.</li> </ol>

# ILLUSTRATED PARTS LIST

FOR PART DESCRIPTION SEE NEXT PAGE

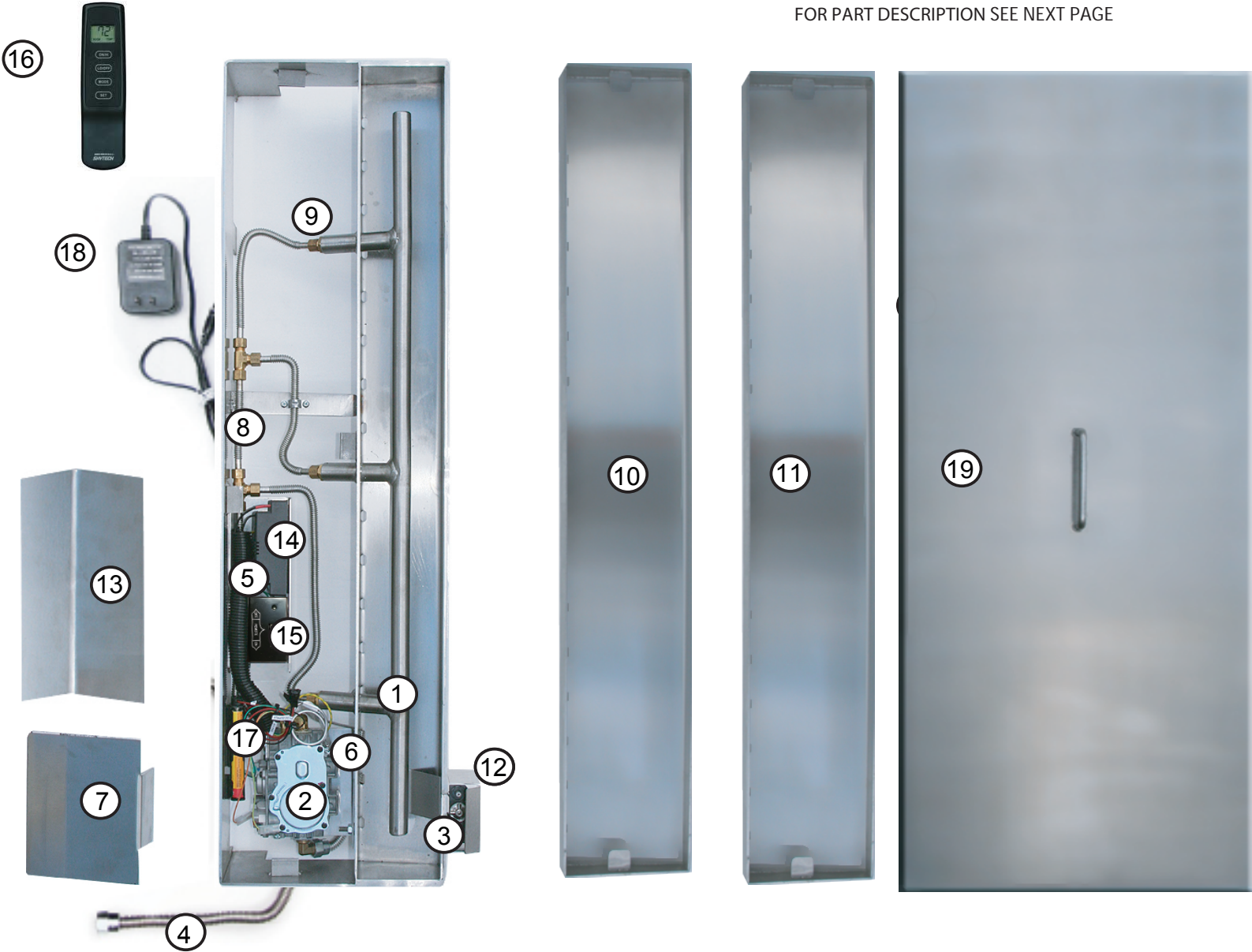

## PARTS LIST

**This list contains replaceable parts used in your Fire Feature appliance**

All replacement parts should be ordered from your retailer or from  
Woodbridge Fireplace Inc. at 1-905-564-3001 or on-line at  
[www.woodbridgedealer.com](http://www.woodbridgedealer.com)

Key #	Part Description	Part Number according to the Fire Feature Natural Gas model (and Propane)							Q-ty
		FF24	FF36	FF48	FF60	FF72	FF84	FF96	
1	Burner Assembly NG (Propane)	W110202 (W120202)	W120203 (W120203)	W110204 (W120204)	W120205 (W120205)	W110206 (W120206)	W110207 (W120207)	W110208 (W120208)	1
2	Main Gas Valve NG (Propane)	R100026 (R100027)	R100026 (R100027)	R100026 (R100027)	R100026 (R100027)	R100026 (R100027)	R100026 (R100027)	R100026 (R100027)	1
3	Pilot Assembly NG (Propane)	R100028 (R100029)	R100028 (R100029)	R100028 (R100029)	R100028 (R100029)	R100028 (R100029)	R100028 (R100029)	R100028 (R100029)	1
4	Burner Flex Connector	C100010	C100010	D300098	D300098	D300098	D300098	D300098	1
5	DFC Wire Assembly	H100141	H100141	H100141	H100141	H100141	H100141	H100141	1
6	Valve Bracket (NOT SHOWN)	D400260	D400260	D400260	D400260	D400260	D400260	D400260	1
7	Valve Heat Shield	D400261	D400261	D400261	D400261	D400261	D400261	D400261	1
8	Manifold complete with Tubing Assembly NG (Propane)	MISC. (MISC.)	MISC. (MISC.)	W130204 (MISC.)	W130205 (MISC.)	W130206 (MISC.)	W130207 (MISC.)	W130208 (MISC.)	1
<i>Continued on Next Page</i>									



## PARTS LIST (CONTINUED)

This list contains replaceable parts used in your Fire Feature appliance

Key #	Part Description	Part Number according to the Fire Feature Natural Gas model (and Propane)							Q-ty
		FF24	FF36	FF48	FF60	FF72	FF84	FF96	
9	Orifice for NG models (Air mixer for propane models)	R100044 (R200061)	R100044 (R200062)	R100043 (R200063)	R100043 (R200064)	R100043 (R100066)	R100043 (R100063)	R100043 (R200067)	SEE PAGE # 7
10	Front Tray	D400234	D400254	D400253	D400209	D400217	D400224	D400210	1
11	Rear Tray	W100286	W100287	W100288	W100289	W100290	W100291	W100292	1
12	Pilot Shield	D400267 (D400290)	D400267 (D400290)	D400267 (D400290)	D400267 (D400290)	D400267 (D400290)	D400267 (D400290)	D400267 (D400290)	1
13	Control Heat Shield	D400265	D400265	D400265	D400265	D400265	D400265	D400265	1
14	DFC Board	H100142	H100142	H100142	H100142	H100142	H100142	H100142	1
15	Remote Receiver	RCB-R	RCB-R	RCB-R	RCB-R	RCB-R	RCB-R	RCB-R	1
16	Remote Control	RCB	RCB	RCB	RCB	RCB	RCB	RCB	1
17	6 Volt Battery Pack	H100139	H100139	H100139	H100139	H100139	H100139	H100139	1
18	7V 10mA DC adapter	H100140	H100140	H100140	H100140	H100140	H100140	H100140	1
19	Enclosure Cover	W100279	W100280	W100281	W100282	W100283	W100284	W100285	1
-	Burner Glass Media /standard/	G100030	G100030	G100030	G100030	G100030	G100030	G100030	Pkg
-	Topping Media	MISC.	MISC.	MISC.	MISC.	MISC.	MISC.	MISC.	Pkg

.....

# ProFlame System Configuration

(880 ON/OFF Wiring Diagram)

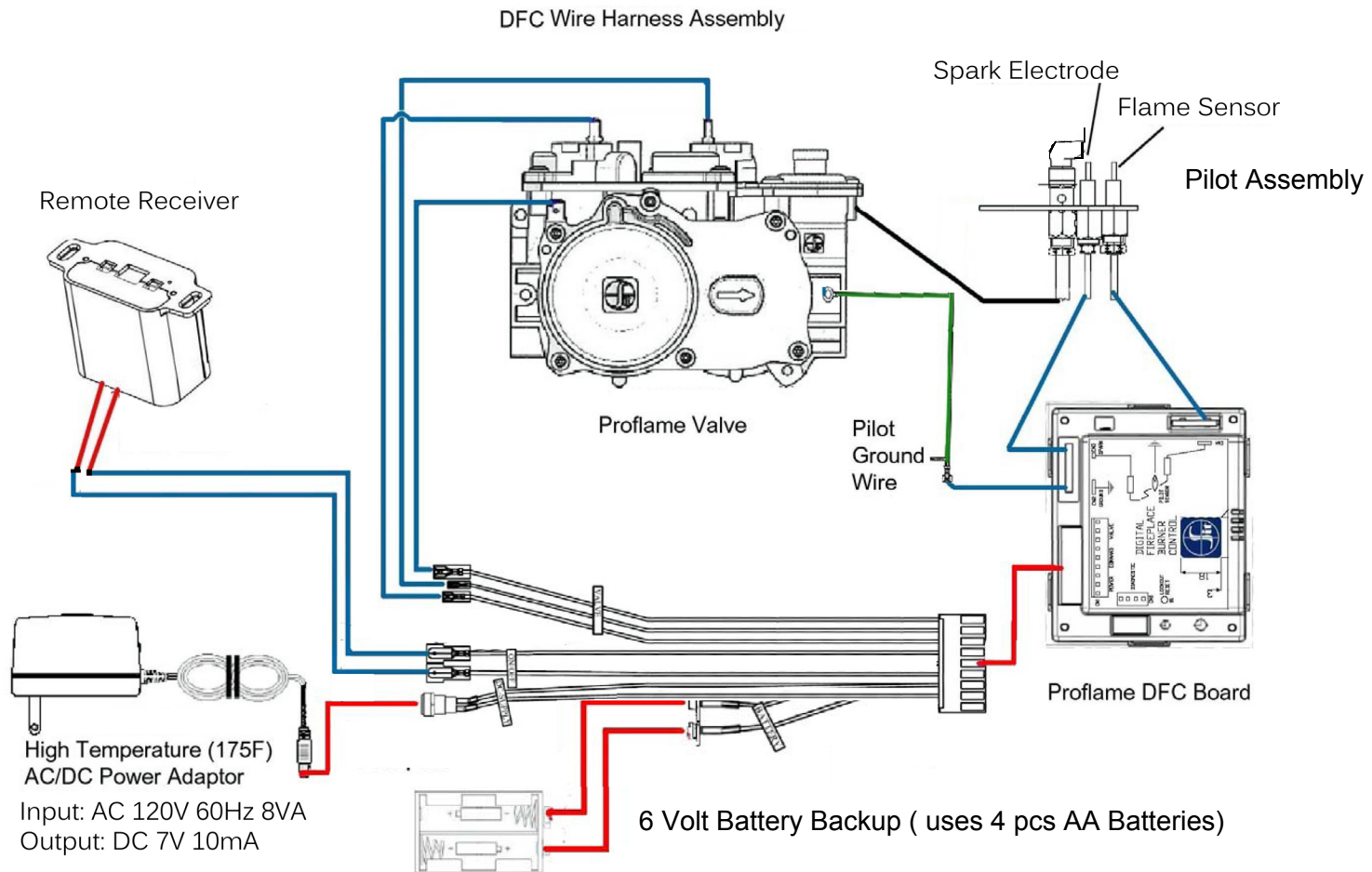

# INSTALLATION RECORD

The installer should complete the form below that describes the details of the installation. Having this written record of installation information available will greatly expedite trouble-shooting should any problem arise with your fireplace. The installer should keep a duplicate of this form for their records. Accurate completion of this form is required for warranty coverage and for any technical support by Woodbridge Fireplace Inc.

<b>Date Purchased:</b>
<b>Purchaser/Dealer:</b>
<b>Installer:</b>
<b>Fireplace S/N on product ID tag:</b>
<b>Date Installed:</b>

**FUEL:**       Natural Gas                       Propane

Inlet Pressure Measured After Installation:	<i>In. W.C.</i>
Manifold Pressure Measured After Installation:	
High Fire:	<i>In. W.C.</i>
Low Fire:	<i>In. W.C.</i>

**CONFIGURATION:**

<b>ALTITUDE:</b> <i>Feet Above Sea Level</i>	
Was Fireplace Derated? <input type="radio"/> Yes <input type="radio"/> No	
If Yes To What Orifice Size?	
Unusual Structure Near Appliance?	
<input type="radio"/> Inside Corner <input type="radio"/> Trees/Shrubs <input type="radio"/> Other	
Termination: <i>(Please Describe)</i>	
Prevalent Wind Conditions?	
Other Installation Notes:	

# WARRANTY INFORMATION

## KEEP THIS FOR WARRANTY

Model _____
Serial No. _____
Date Purchased _____

Always specify model and serial numbers when communicating with the factory.

## LIMITED LIFETIME WARRANTY

The following components are warranted for life to the original owner, subject to proof of purchase:  
Burner Assembly.

### BASIC WARRANTY

Woodbridge Fireplace Inc. warrants the components and materials in your appliance to be free from manufacturing and material defects for a period of two years from date of installation. After installation, if any of the components manufactured by Woodbridge Fireplace in the appliance are found to be defective in materials or workmanship, Woodbridge Fireplace will, at its option, replace or repair the defective components at no charge to the original owner. Woodbridge Fireplace will also pay for reasonable labor cost incurred in replacing or repairing such components for a period of two years from date of installation. Any products presented for warranty repair must be accompanied by a dated proof of purchase.

This Limited Lifetime Warranty will be void if the appliance is not installed by a qualified installer in accordance with installation instructions. The Limited Lifetime Warranty will also be void if the appliance is not operated and maintained according to the operating instructions supplied with the appliance, and does not extend to (1) firebox/burner assembly damaged by accident, neglect, misuse, abuse, alterations, negligence of others, including the installation thereof by unqualified installers, (2) the costs of removal, reinstallation or transportation of defective parts on the appliance, or (3) incidental or consequential damage. All service work must be performed by an authorized service representative.

This warranty is expressly in lieu of other warranties, express or implied, including the warranty of merchantability of fitness for purpose and of all other obligations or liabilities. Woodbridge Fireplace does not assume for it any other obligations or liabilities in connection with sale or use of the appliance. In states that do not allow limitations on how long an implied warranty lasts, or do not allow exclusion of indirect damage, those limitations of exclusions may not apply to you. You may also have additional right not covered in the Limited Lifetime Warranty. Woodbridge Fireplace reserves the right to investigate any and all the claims against this Warranty and decide upon method of settlement. For information about this warranty contact:

**Woodbridge Fireplace Inc.**  
**1305 Meyerside Dr., Mississauga**  
**Ontario, Canada L5T 1C9**  
**Tel.: 1-905-564-3001**  
[www.woodbridgedealer.com](http://www.woodbridgedealer.com)