

# Woodbridge Fireplace Inc.



## INDOOR FIRE FEATURE VENTED DECORATIVE APPLIANCE

### OWNER'S OPERATION AND INSTALLATION MANUAL



Report # 0401GL022S

Complies with:

ANSI Z21.60-2017/CSA 2.26-2017 "Decorative gas appliances for installation in solid-fuel burning fireplaces", CAN/CGA 2.17-M91 "Gas appliances for use at high altitudes"

**WARNING:** If the information in this manual is not followed exactly, a fire or explosion may result causing property damage, personal injury, or loss of life.

- Installation and service must be performed by a qualified installer, service agency, or the gas supplier.
- Do not store or use gasoline or other flammable vapors and liquids in the vicinity of this or any other appliance.
- **WHAT TO DO IF YOU SMELL GAS:**
  - Do not try to light any appliance.
  - Do not touch any electrical switch; do not use any phone in your building.
  - Immediately call your gas supplier from a neighbor's phone. Follow the gas supplier's instructions.
  - If you cannot reach your gas supplier, call the fire department.

**WARNING:** Improper installation, adjustment, alteration, service, or maintenance can cause injury or property damage. Refer to this manual for correct installation and operational procedures. For assistance or additional information consult a qualified installer, service agency, or gas supplier.

**WARNING:** This appliance is for installation only in a solid-fuel burning masonry or UL127 factory-built fireplace, constructed of noncombustible material, and connected to a working flue (*see page 4 for minimum flue opening*).

**WARNING:** This is a gas-fired appliance. It uses air (oxygen) from the room in which it is installed. Provisions for adequate combustion and ventilation air must be provided.

**INSTALLER:** Leave this manual with the appliance.  
**CONSUMER:** Retain this manual for future reference

***NOTE: This appliance is not approved for installation in bedrooms or bathrooms.***

Version française de ce manuel est disponible à partir du site WEB : [www.woodbridgedealer.com](http://www.woodbridgedealer.com)  
French version of this Owners Manual is available at [www.woodbridgedealer.com](http://www.woodbridgedealer.com)

## SAFETY INFORMATION

**⚠ WARNING: Keep flue open when operating unit.**

**IMPORTANT: Fireplace doors must be open when appliance is operating.**

**IMPORTANT: Read this owner's manual carefully and completely before trying to assemble, operate, or service this Fire Feature. Improper use of this unit can cause serious injury or death from burns, fire, explosion, electrical shock, and carbon monoxide poisoning.**

**⚠ DANGER: Carbon monoxide poisoning may lead to death!**

**Carbon Monoxide Poisoning:** Early signs of carbon monoxide poisoning resemble the flu, with headaches, dizziness, or nausea. If you have these signs, the Fire Feature may not be working properly. **Get fresh air at once!** Have Fire Feature serviced. Some people are more affected by carbon monoxide than others. These include pregnant women, people with heart or lung disease or anemia, those under the influence of alcohol, and those at high altitudes.

**Natural and Propane Gas:** Natural and propane gases are odorless. An odor making agent is added to the gas. The odor helps you detect a gas leak. However, the odor added to the gas can fade. Gas may be present even though no odor exists.

Make certain you read and understand all warnings. Keep this manual for reference. It is your guide to safe and proper operation of this Fire Feature.

**⚠ WARNING: Any change to this Fire Feature or its controls can be dangerous.**

1. This appliance, as supplied, is only for use with the type of gas indicated on the rating plate.
2. If you smell gas:
  - shut off gas supply
  - do not try to light any appliance
  - do not touch any electrical switch; do not use any phone in your building
  - immediately call to your gas supplier from a neighbor's phone. Follow the gas supplier's instructions
  - if you cannot reach your gas supplier, call the fire department
3. Never install the Fire Feature:
  - in a recreational vehicle
  - where curtains, furniture, clothing, or other flammable objects are less than 42 inches from the front, top, or sides of the Fire Feature.
  - in the high traffic areas
  - in windy or drafty areas
4. Before installing in a solid fuel burning fireplace, the chimney flue and firebox must be cleaned of soot, creosote, ashes and loose paint by a qualified chimney cleaner. Creosote will ignite if highly heated. Inspect chimney flue for damage.
5. Fire Feature is designed to be smokeless. If it ever appears to smoke, turn off appliance and call a qualified service person. **NOTE:** During initial operation, slight smoking could occur due to unit curing and the burning of manufacturing residues.
6. To reduce the creation of soot, follow the instructions in *Cleaning and Maintenance*, page 9.
7. Do not allow fans to blow directly into the fireplace. Avoid any drafts that alter burner flame patterns, as it could increase soot.
8. Do not use a blower insert, heat exchanger insert or other accessory not approved for use with this Fire Feature.
9. This Fire Feature needs fresh, outside air ventilation to run properly.
10. Keep the appliance area clear and free from combustible materials, gasoline and other flammable vapors and liquids.
11. Do not burn solid fuel in the fireplace after installing the Fire Feature. Do not use this appliance to cook food or burn paper or other objects.
12. The Fire Feature becomes hot when in use. Keep children and adults away from hot surface to avoid burns or clothing ignition. Fire Feature will remain hot for a time after shut-down. Allow surface to cool before touching.
13. Carefully supervise young children when they are in the room with Fire Feature.
14. Do not use appliance if any part has been exposed to or under water. Immediately call a qualified service technician to inspect the room appliance and to replace any part of the

control system and any gas control which has been under water.

15. Turn the fireplace off and let it cool before servicing, installing, or repairing. Only a qualified service person should install, service, or repair Fire Feature.

## LOCAL CODES

Install and use Fire Feature with care. Follow local codes. In the absence of local codes, use the latest edition of The National Fuel Gas Code ANSZ223.1, also known as NFPA 54 available from:

- American National Standards Institute, Inc., 1430 Broadway, New York, NY 10018
- National Fire Protection Association, Inc., Batterymarch Park, Quincy, MA 02269.

## PRODUCT ASSEMBLY

**WARNING: Failure to position the parts in accordance with these diagrams or failure to use only parts specially approved with this appliance may result in property damage or personal injury.**

1. Remove Burner Assembly, Front Cover, Access Panel and Burner Media from

packaging (see *Parts List*, page 14).

2. Connect the Burner Assembly to gas supply using supplied flex connector and shutoff valve.
3. Evenly fill the media compartment with burner media (broken tempered glass) fully covering the burner as shown on a picture.

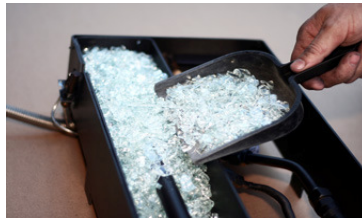

If you are NOT planning to add optional topping media, then fill the media compartment in full and proceed to the step 5.

**NOTE:** If you are planning to add some topping media (optional colored glass or lava rock), leave approximately  $\frac{3}{4}$ " not filled on top of burner media and proceed to the next step.

4. Place and evenly distribute topping media (optional colored glass or lava rock) on top of burner media as shown on a picture.



Make sure that pilot opening is not blocked with excess of media.

5. Carefully leak test all connections following the procedure on page 5.
6. Having free access to the valve and manifold compartment of the Burner Assembly turn ON the appliance following the procedure on page 7.

Make sure the flame is even along the burner and appliance is fully operational and safe for use. Turn OFF the appliance and let it cool before proceeding to the next step.

7. Cover manifold and valve compartment of the Burner Assembly with Front Cover making sure that access window is located above the valve as shown on a picture.



Cover the window with Access Panel as shown on a picture.



## INSTALLATION

**⚠ CAUTION:** Do not remove the metal data plates attached to the Fire Feature. These plates contain important information.

**⚠ WARNING:** Before installing in a solid fuel burning fireplace, the chimney flue and firebox must be cleaned of soot, creosote, ashes and loose paint by a qualified chimney cleaner. Creosote will ignite if highly heated. A dirty chimney flue may create and distribute soot within the house. Inspect chimney flue for damage.

**NOTICE:** Installation, service, and repair of this appliance must be performed by a qualified installer, service agency, company or gas supplier experienced with this type of gas appliances. Only factory authorized components listed in this instruction may be used in accordance with the manufacturer's instructions and all codes and requirements of the authority having jurisdiction. Any modifications to this appliance or use of unauthorized components or accessory items will void the manufacturer's warranty, and may result in a hazardous condition.

**NOTE:** This vented appliance must be installed only in a solid-fuel burning fireplace with a working flue and constructed of noncombustible material. The installation of appliances designed for manufactured home (U.S.

only) or mobile home installation must conform with the Standard *CAN/CSA Z240 MH, Mobile Housing*, in Canada, or with the *Manufactured Home Construction and Safety Standard, Title 24 CFR, Part 3280*, in the USA, or when such a standard is not applicable, *ANSI/NCSBCS A225.1/NFPA 501A, Manufactured Home Installations Standard*.

**The fireplace must include a working flue and venting system with minimum opening.** Please, make sure that the following technical data related to proper installation of the Fire Feature are applicable before installation is attempted.

### Minimum firebox size:

- Height	18"
- Depth	14"
<b>- Width/Model:</b>	
IFF-24.....	28"
IFF-36.....	40"
IFF-48.....	52"
IFF-60.....	64"
IFF-72.....	76"
IFF-84.....	88"
IFF-96.....	100"

### Fuel Pressure Specification:

- Inlet (NG)	4.5.-10.5" w.c.
- Manifold (NG)	3.5" w.c.
- Inlet (Propane)	11-13" w.c.
- Manifold (Propane)	10" w.c.

## VENTING SPECIFICATIONS FOR INSTALLATION

The fireplace chimney flue and vent must be drafting properly. To check the vent for proper drafting:

Light a tightly rolled newspaper on the end and place it at the inside front edge of the fireplace. Observe the smoke and be sure the vent is properly drawing it up the chimney. If the smoke spills out into the room, extinguish the flame and remove any obstruction until proper venting is achieved. The chimney flue must remain open a minimum of 3" at all times during the operation of this Fire Feature.

## INSTALLING DAMPER CLAMP

Secure the damper stop clamp provided to the leading edge of the damper as shown below. If for any reason this clamp doesn't work on your fireplace, another suitable clamp or permanent stop must be installed, or the damper blade must be cut or removed.

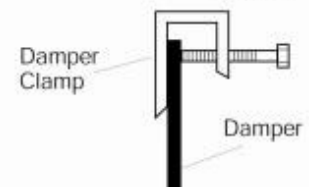
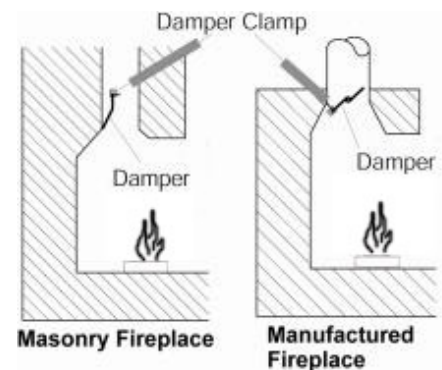

## CHECK GAS TYPE

Use proper gas type for the fireplace you are installing. If you have conflicting gas type, do not install fireplace. See dealer where you purchased the fireplace for proper fireplace for your gas type or conversion kit.

## INSTALLING GAS PIPING TO FIREPLACE / BURNER SYSTEM LOCATION

### WARNING

A qualified installer or service person must connect appliance to gas supply. Follow all local codes.

### CAUTION

For propane units, never connect fireplace directly to the propane supply. This burner system requires an external regulator (not supplied). Install the external regulator between the burner system and propane supply.

## INSTALLATION ITEMS NEEDED

Before installing fireplace and burner system, make sure you have the items listed below.

- External regulator (supplied by installer)
- Equipment shutoff valve\*
- Tee joint
- approved flexible gas line with gas connector (if allowed by local codes — not provided)
- Piping (check local codes)
- Test gauge connection\*
- Pipe wrench
- Sealant (resistant to propane gas)
- Sediment trap (recommended)

\* A CSA design-certified equipment shutoff valve with  $\frac{1}{8}$ " NPT tap is an acceptable alternative to test gauge connection. Purchase the CSA design-certified equipment shutoff valve from your dealer.

For propane connections only, the installer must supply an external regulator. The external regulator will reduce incoming gas pressure. You must reduce incoming gas pressure to between 11 and 13 inches of water. If you do not reduce incoming gas pressure, burner system regulator damage could occur. Install external regulator with the vent pointing down as shown in *Figure 32*. Pointing the vent down protects it from freezing rain or sleet.

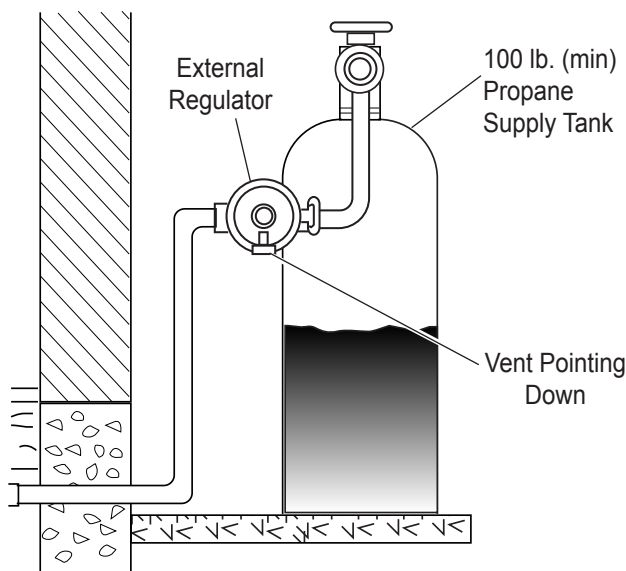

**Figure 32 - External Regulator with Vent Pointing Down (Propane Only)**

### CAUTION

Use only new black iron or steel pipe. Internally tinned copper or copper tubing can be used per National Fuel Code, section 2.6.3, providing gas meets hydrogen sulfide limits, and where permitted by local codes. Gas piping system must be sized to provide minimum inlet pressure (listed on data plate) at the maximum flow rate (BTU/hr). Undue pressure loss will occur if the pipe is too small.

When using copper or flex connectors use only fittings approved for gas connections. The gas control inlet is  $\frac{3}{8}$ " NPT.

## FIREPLACE INSTALLATION

### WARNING

Only persons licensed to work with gas piping may make the necessary gas connections to this appliance.

### CAUTION

A manual shutoff valve must be installed upstream of the appliance. Union tee and plugged  $\frac{1}{8}$ " NPT pressure tapping point should be installed upstream of the appliance. See Figure 33.

**NOTE :** The gas line connection may be made using  $\frac{1}{2}$ " rigid tubing or an approved flex connector. Since some municipalities have additional local codes it is always best to consult your local authorities and the current edition of the National Fuel Gas Code ANSI.Z223.1, NFPA54. In Canada CAN/CGA-B149 (1 or 2) Installation Code.

A listed manual shutoff valve must be installed upstream of the appliance. Union tee and plugged  $\frac{1}{8}$ " NPT pressure tapping point should be installed upstream of the appliance. See Figure 33.

**IMPORTANT:** Install main gas valve (equipment shutoff valve) in an accessible location. The main gas valve is for turning on or shutting off the gas to the fireplace.

Check your building codes for any special requirements for locating equipment shutoff valve to fireplaces.

Apply pipe joint sealant lightly to male threads. This will prevent excess sealant from going into pipe. Excess sealant in pipe could result in clogged burner system valves.

We recommend that you install a sediment trap/drip leg in supply line as shown in Figure 33. Locate sediment trap/drip leg where it is within reach for cleaning. Install in piping system between fuel supply and burner system. Locate sediment trap/drip leg where trapped matter is not likely to freeze. A sediment trap traps moisture and contaminants. This keeps them from going into the burner system gas controls. If sediment trap/drip leg is not installed or is installed wrong, burner system may not run properly.

### CAUTION

Use pipe joint sealant that is resistant to liquid petroleum (LP) gas.

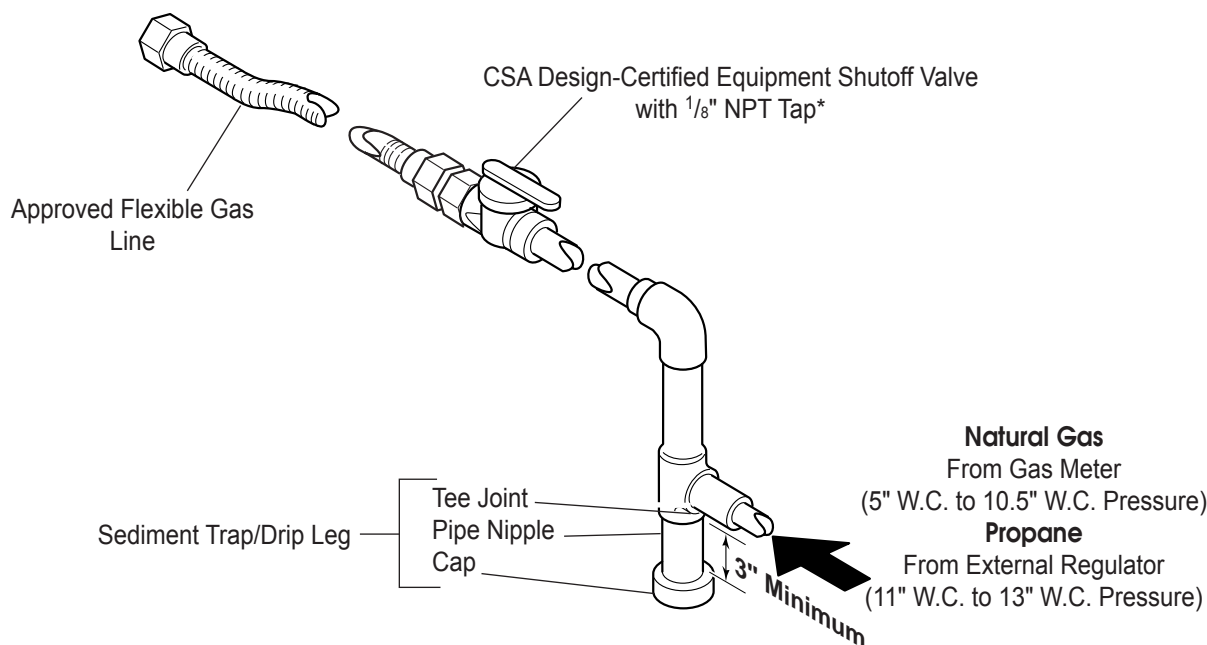
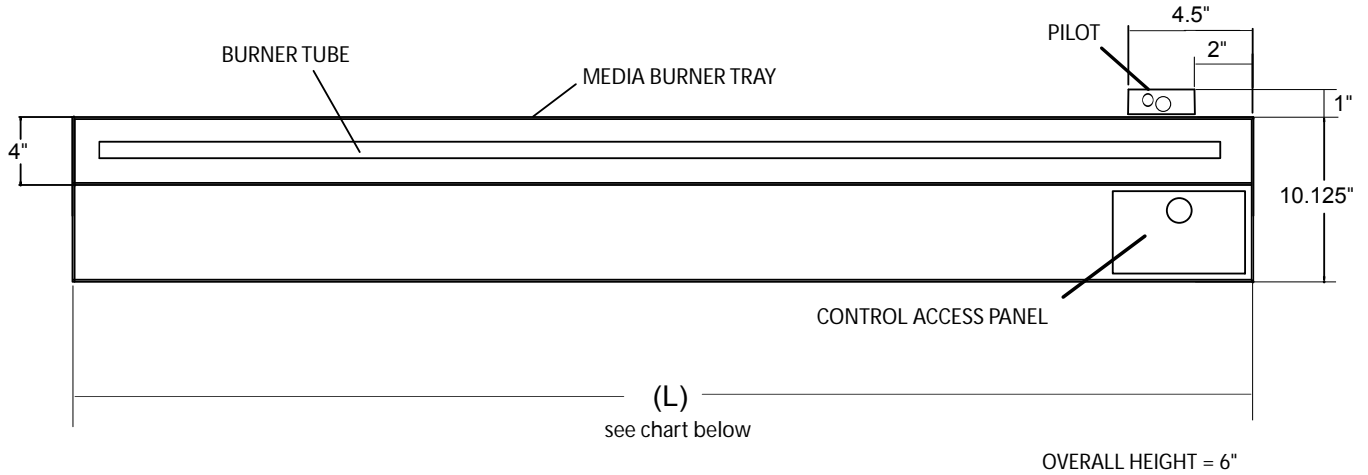

Figure 33 - Gas Connection

INDOOR FIRE FEATURE BURNER  
MODEL SPECIFICATIONS

TOP VIEW



MODEL #	OVERALL LENGTH (L)	FIREPLACE WIDTH (min)	INPUT RATE (BTU/Hr)		# ORIF. N.G. (P)	ORIF. SIZE	
			N.G.	Propane		N.G.	Propane
<b>IFF - 24</b> - NG/P	<b>24.125"</b>	28"	<b>40,000</b>	33,500	2 (1)	44	49
<b>IFF - 36</b> - NG/P	<b>36.125"</b>	40"	61,000	54,000	3 (1)	44	43
<b>IFF - 48</b> - NG/P	<b>48.125"</b>	52"	82,000	72,000	4 (1)	43	38
<b>IFF - 60</b> - NG/P	<b>60.125"</b>	64"	102,000	90,000	5 (2)	43	46
<b>IFF - 72</b> - NG/P	<b>72.125"</b>	76"	<b>106,000</b>	110,000	6 (2)	43	41
<b>IFF - 84</b> - NG/P	<b>84.125"</b>	<b>88"</b>	<b>110,000</b>	128,000	7 (2)	43	38
<b>IFF - 96</b> - NG/P	<b>96.125"</b>	100"	<b>116,000</b>	<b>140,000</b>	8 (2)	43	35

Minimum fireplace depth required = 14"

Minimum fireplace height required = 18"

# LIGHTING INSTRUCTION

## FOR YOUR SAFETY READ BEFORE LIGHTING

### WARNING

If you do not follow these instruction exactly, a fire or explosion may result causing property damage, personal injury or loss of life.

- A. This appliance is equipped with a pilot which must be lit by hand while following these instructions exactly.
- B. BEFORE OPERATING smell all around the appliance area for gas. Be sure to smell next to the floor because some gas is heavier than air and will settle on the floor.

### WHAT TO DO IF YOU SMELL GAS:

- Do not try to light any appliance.
  - Do not touch any electric switch; do not use any phone in your building.
  - Immediately call your gas supplier from a neighbor's phone.  
Follow the gas supplier's instructions.
  - If you cannot reach your gas supplier, call the fire department.
- C. Use only your hand to push in, or turn the gas control knob. Never use tools. If the knob will not push in or turn by hand, don't try to repair it. Call a qualified service technician. Force or attempted repair may result in a fire or explosion.
  - D. Do not use this appliance if any part of it has been under water. Immediately call a qualified service technician to inspect the appliance and to replace any part of the control system and any gas control that has been under water.

## LIGHTING PILOT FOR THE FIRST TIME

### INITIAL LIGHTING

Purge air from the supply line as follows:

- Open main shutoff valve.
- Unscrew main pressure test point.
- Leave inlet test screw open until gas comes in.
- When gas is flowing, tighten inlet screw immediately.

### DANGER

Never use an open flame to check for gas leak.

### LEAK TESTING

1. Follow the pipe from the gas supply line connection to the gas valve. Check connection for leaks with soap and water mixture.
2. Next check for gas leaks at the burner with soap and water mixture.
3. Check the pilot for gas leaks with soap and water mixture.



## LIGHTING PILOT FOR THE FIRST TIME

### APPROVED LEAK TESTING METHOD

You may check for gas leaks with the following methods only:

- Soap and water solution
- An approved leak testing spray
- Electronic sniffer

### DANGER

Never use an open flame to check for gas leak.

### WARNING

If using a soap and water solution to test for leaks, DO NOT spray solution onto control body.

*NOTE: Remove any excessive pipe compound from the connections. Excessive pipe compound can set off electronic sniffers.*

Check for gas leaks in each of the following locations:

- Pipe from the gas supply line connection to the gas valve
- Burner connections, pilot
- All joints on valve and control body
- Field made joints / gas shutoff valve
- Factory made joints, each joint and connection

## LIGHTING INSTRUCTIONS

1. **STOP! Read the safety information on previous page.**
2. Remove lower cover.
3. Turn the gas control knob to the "OFF" position.
4. Wait five (5) minutes to clear out any gas. If you then smell gas, STOP! Follow "B" in the safety information on the previous page. If you don't smell gas, go to the next step.
5. Locate the Pilot Assembly on the back of Fire Feature.

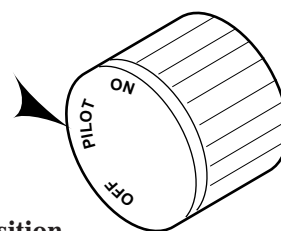
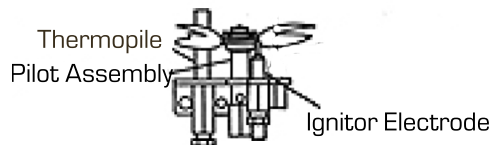

Knob at Pilot Position

6. Depress and turn pilot gas knob counterclockwise to "PILOT" position.
7. Depress fully and hold pilot gas knob.  
**Light pilot with a match or barbecue lighter.**  
 Keep knob fully depressed for a few seconds. Release and check that pilot continues to burn.
  - If the pilot does not stay lit, repeat steps 1 and 2.
  - If the pilot knob does not pop up when released, STOP and immediately call service technician or gas supplier
  - If the pilot will not stay lit after several tries, turn the gas control knob to "OFF" position and call your service technician or gas supplier.

## LIGHTING BURNER

### MAIN BURNER SWITCH

The "ON/REMOTE/OFF" switch for the main burner can be found on remote control receiver beneath the cover. This switch allows you to turn on and to turn off the main burner without using the gas valve knob. Make sure the button is in the "ON" position to operate the main burner.

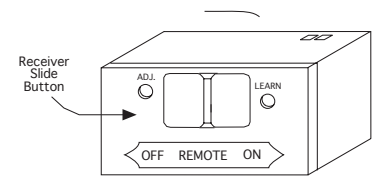

### LIGHTING THE BURNER

Depress and turn the knob counterclockwise  to the "ON" position. It will take less than four (4) seconds for the burner to ignite.

*On/Off Switch*

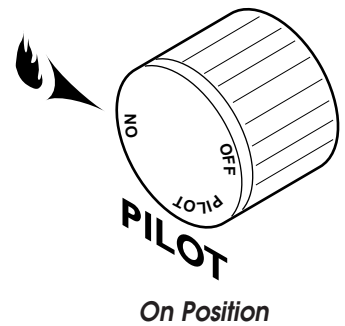

### PILOT POSITION

Depress and turn knob to pilot position to keep burner off while maintaining the pilot light.

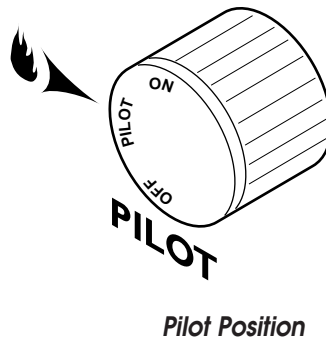

*Pilot Position*

## TO TURN OFF GAS TO APPLIANCE

1. Remove lower cover. Depress and turn knob clockwise  to "OFF" position.
2. Replace lower cover.

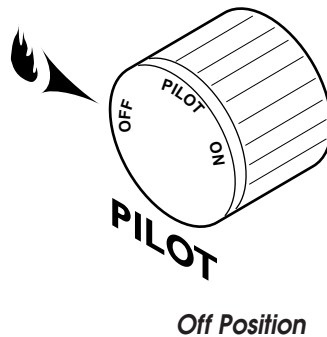

*Off Position*

## CLEANING AND MAINTENANCE

### WARNING

Turn off gas before servicing fireplace. It is recommended that a qualified service technician perform these check-ups at the beginning of each heating season.

### BURNER, PILOT AND CONTROL COMPARTMENT

Keep the control compartment clean by vacuuming or brushing at least twice a year. Make sure the burner porting, pilot air opening and burner air opening are free of obstructions at all times.

### PILOT FLAME

The flames from the pilot should be visually checked as soon as the unit is installed and periodically during normal operation. **The pilot flame must always be present when the fireplace is in operation.** The pilot flame has two distinct flames, one engulfing the thermopile and the other reaching to the main burner.

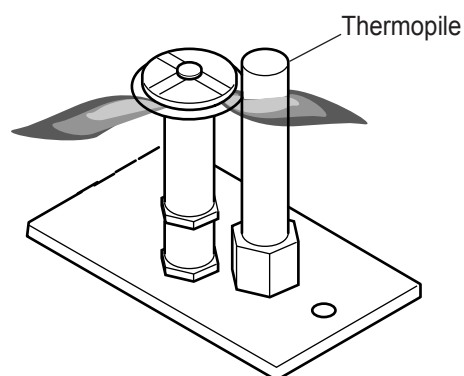

Pilot Flame

### BURNER

Inspect area around the injector. Remove any lint or foreign material with a brush or vacuum.

### WARNING

Do not operate the appliance without the burner being completely filled with glass media. Lighting the burner without the glass media will cause unsafe temperatures within the appliance.

### VENTING SYSTEM

Have the venting system of the solid fuel burning fireplace inspected and cleaned annually by a qualified agency.

## TROUBLESHOOTING

**⚠ WARNING: Turn off the fireplace and let it cool before servicing. Only a qualified service person should service and repair this appliance.**

*Note:* All troubleshooting items are listed in order of operation.

POSSIBLE CAUSE	REMEDY	
<p>Unit is smoking / sooting excessively (<i>Note:</i> It is natural and unavoidable for appliance sets to produce moderate levels of carbon (soot) where flames contact the media. This is especially true with propane gas.)</p>	<ol style="list-style-type: none"> <li>1. Poor fuel quality</li> <li>2. Fireplace venting system not drafting properly</li> <li>3. Excessive flame impingement or blockage</li> <li>4. Improper fuel/air mixture</li> </ol>	<ol style="list-style-type: none"> <li>1. Contact local natural or propane gas company</li> <li>2. Adjust damper wide open and/or have fireplace and venting professionally cleaned and checked</li> <li>3. Separate the stones to allow more flame passage</li> <li>4. Remove any foreign items from the flame pattern and/or check for proper orifice sizing</li> </ol>
<p>Burner is excessively noisy (<i>Note:</i> The movement and combustion of gas will create low, unavoidable levels of noise.)</p>	<ol style="list-style-type: none"> <li>1. Passage of air/gas across irregular surfaces</li> <li>2. Excessive gas pressure on natural gas units</li> </ol>	<ol style="list-style-type: none"> <li>1. Relieve any tight bends or kinks in gas supply line</li> <li>2. Check/reset gas regulator pressure</li> </ol>
<p>Burner flame is too low or too high</p>	<ol style="list-style-type: none"> <li>1. Incorrect gas supply or pressure</li> <li>2. Blocked burner orifice or burner manifold ports</li> <li>3. Improper burner orifice size</li> </ol>	<ol style="list-style-type: none"> <li>1. Check for proper gas supply pressure</li> <li>2. Free burner orifice and manifold ports of any burrs, paint, or other blockage</li> <li>3. Verify proper burner orifice sizing (see page 6)</li> </ol>
<p>Remote does not function</p>	<ol style="list-style-type: none"> <li>1. Battery is not installed. Battery power is low</li> </ol>	<ol style="list-style-type: none"> <li>1. Replace batteries in receiver and remote control</li> </ol>

OBSERVED PROBLEM	POSSIBLE CAUSE	REMEDY
<p><b>IMPORTANT:</b> Operating unit where impurities in air exist may create odors. Cleaning supplies, paint, paint remover, cigarette smoke, cements and glues, new carpet or textiles, etc., create fumes. These fumes may mix with combustion air and create odors. These odors will disappear over time.</p>		
<p><b>⚠ WARNING: If you smell gas</b></p> <ul style="list-style-type: none"> <li>• <b>Shut off gas supply.</b></li> <li>• <b>Do not try to light any appliance.</b></li> <li>• <b>Do not touch any electrical switch; do not use any phone in your building.</b></li> <li>• <b>Immediately call your gas supplier from a neighbor's phone. Follow the gas supplier's instructions.</b></li> <li>• <b>If you cannot reach your gas supplier, call the fire department.</b></li> </ul>		
Pilot lights but flame goes out when control knob is released	<ol style="list-style-type: none"> <li>1. Control knob not fully pressed in</li> <li>2. Control knob not pressed in long enough</li> <li>3. Manual shutoff valve not fully open</li> <li>4. Pilot flame not touching thermopile, which allows thermopile to cool, causing pilot flame to go out. This problem could be caused by one or both of the following:               <ol style="list-style-type: none"> <li>A) Low gas pressure</li> <li>B) Dirty or partially clogged pilot</li> </ol> </li> <li>5. Thermopile connection loose at control valve</li> <li>6. Thermopile damaged</li> <li>7. Control valve damaged</li> </ol>	<ol style="list-style-type: none"> <li>1. Press in control knob fully</li> <li>2. After pilot lights, keep control knob pressed in 30 seconds</li> <li>3. Fully open manual shut-off valve</li> <li>4. A) Contact local natural gas company B) Clean pilot (see <i>Cleaning and Maintenance</i>, page 10) or replace pilot assembly</li> <li>5. Hand tighten until snug, then tighten 1/4 turn more</li> <li>6. Replace thermopile</li> <li>7. Replace control valve</li> </ol>
Burner does not light after pilot is lit	<ol style="list-style-type: none"> <li>1. Burner orifice clogged</li> <li>2. Inlet gas pressure is too low</li> <li>3. Burner orifice diameter is too small</li> <li>4. Thermopile leads disconnected or improperly connected</li> </ol>	<ol style="list-style-type: none"> <li>1. Clean burner orifice</li> <li>2. Contact local natural or propane gas company</li> <li>3. Replace burner orifice</li> <li>4. Reconnect leads</li> </ol>
Delayed ignition burner	<ol style="list-style-type: none"> <li>1. Pilot flame needs adjusting</li> </ol>	<ol style="list-style-type: none"> <li>1. Adjust pilot flame for approximately 1" blue flame</li> </ol>

OBSERVED PROBLEM	POSSIBLE CAUSE	REMEDY
Fire Feature produces unwanted odors	<ol style="list-style-type: none"> <li>Unit burning vapors from paint, hair spray, glues, cleaners, chemicals, new carpet, etc. (See <i>IMPORTANT</i> statement above)</li> <li>Gas leak. <b>See Warning statement at top of page</b></li> </ol>	<ol style="list-style-type: none"> <li>Open flue to maximum. Stop using odor causing products while unit is running</li> <li>Locate and correct all leaks (see <i>Checking Gas Connections</i>, page 5)</li> </ol>
Gas odor even when control knob is in OFF position	<ol style="list-style-type: none"> <li>Gas leak. <b>See Warning statement at top of page</b></li> <li>Control valve defective</li> </ol>	<ol style="list-style-type: none"> <li>Locate and correct all leaks (see <i>Checking Gas Connections</i>, page 5)</li> <li>Replace control valve</li> </ol>
Gas odor during combustion	<ol style="list-style-type: none"> <li>Gas leak. <b>See Warning statement at top of page</b></li> </ol>	<ol style="list-style-type: none"> <li>Locate and correct all leaks (see <i>Checking Gas Connections</i>, page 5)</li> </ol>

# ILLUSTRATED PARTS LIST

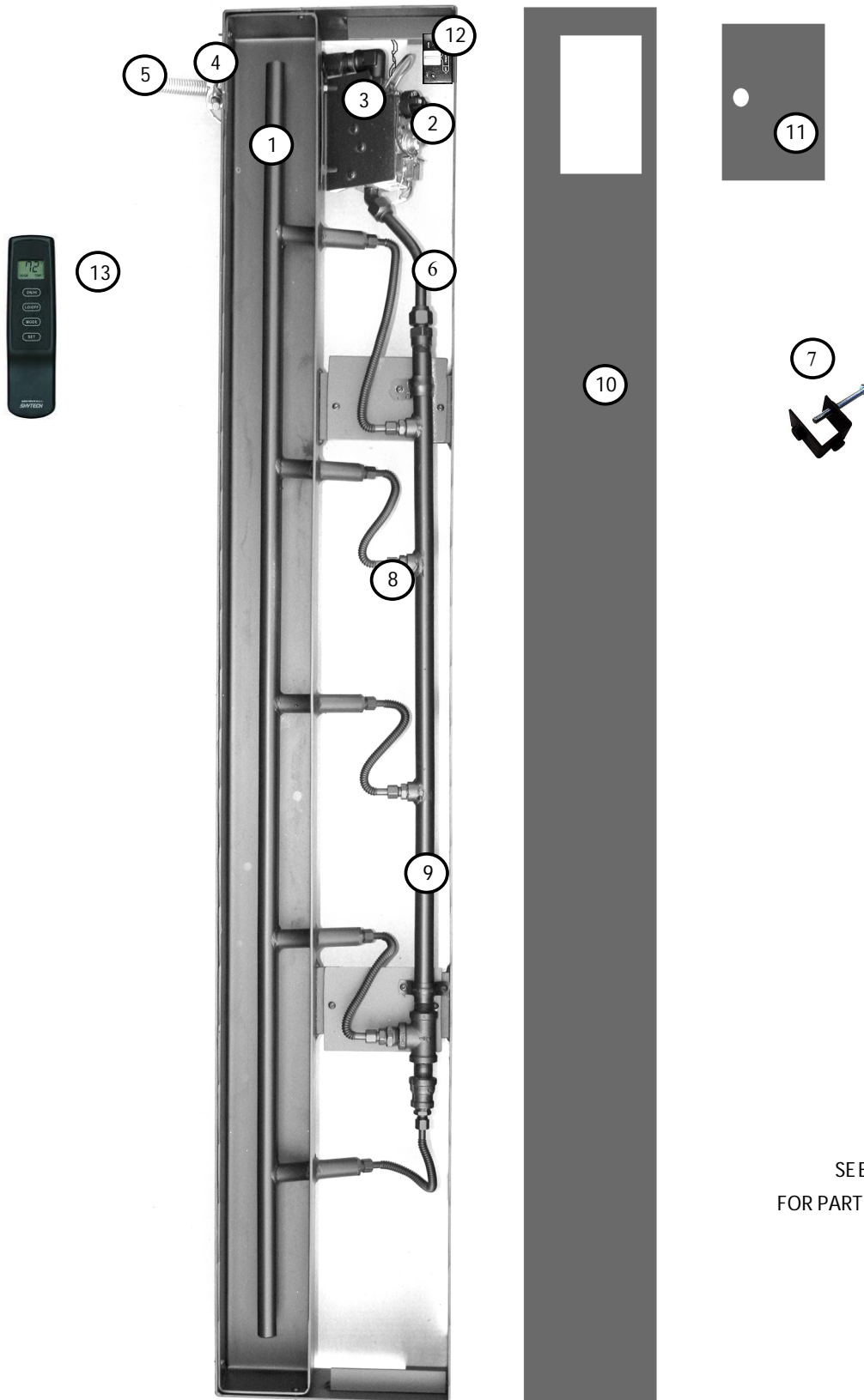

SEE NEXT PAGE  
FOR PART DESCRIPTION

## PARTS LIST

**This list contains replaceable parts used in your Fire Feature appliance**

All replacement parts should be ordered from your retailer or from  
Woodbridge Fireplace Inc. at 1-905-564-3001 or on-line at  
[www.woodbridgedealer.com](http://www.woodbridgedealer.com)

Key #	Part Description	Part Number according to the Indoor Fire Feature Model for Natural Gas (Propane)							Q-ty
		IFF-24	IFF-36	IFF-48	IFF-60	IFF-72	IFF-84	IFF-96	
1	Burner Assembly	R100012 (R200012)	R100013 (R200013)	R100014 (R200014)	R100015 (R200015)	R100016 (R200016)	R100017 (R200017)	R100018 (R200018)	1
2	Main Gas Valve	R100020 (R200020)	R100020 (R200020)	R100020 (R200020)	R100020 (R200020)	R100020 (R200020)	R100020 (R200020)	R100020 (R200020)	1
3	Valve Bracket	R100021	R100021	R100021	R100021	R100021	R100021	R100021	1
4	Pilot Assembly	R100022 (R200022)	R100022 (R200022)	R100022 (R200022)	R100022 (R200022)	R100022 (R200022)	R100022 (R200022)	R100022 (R200022)	1
5	Burner Flex Connector	C100010	C100010	D300098	D300098	D300098	D300098	D300098	1
6	Manifold Flex Connector	C100030	C100030	C100072	C100072	C100072	C100072	C100072	1
7	Damper Clamp	F100037	F100037	F100037	F100037	F100037	F100037	F100037	1
<i>Continued on Next Page</i>									



### PARTS LIST (Continued)

This list contains replaceable parts used in your firebox

Key #	Part Description	Part Number according to the □door □re □e□re Model for Natural Gas (Propane)							Q-ty
		IFF-24	IFF-36	IFF-48	IFF-60	IFF-72	IFF-84	IFF-96	
8	Orifice / Air Mixer	R100044 (R200061)	R100044 (R200062)	R100043 (R200063)	R100043 (R200064)	R100043 (R200066)	R100043 (R200063)	R100043 (R200067)	2 1 3 1 4 1 5 2 6 2 7 2 8 2
		<i>Continued on Next Page</i>							

## PARTS LIST (Continued)

This list contains replaceable parts used in your firebox

Key #	Part Description	Part Number according to the □door □re □e□re Model for Natural Gas (Propane)							Q-ty
		IFF-24	IFF-36	IFF-48	IFF-60	IFF-72	IFF-84	IFF-96	
9	Burner Manifold	R100032 (R200032)	R100033 (R200033)	R100034 (R200034)	R100035 (R200035)	R100036 (R200036)	R100037 (R200037)	R100038 (R200038)	1
10	Front Cover	R100102	R100103	R100104	R100105	R100106	R100107	R100108	1
11	Access Panel	D400058P	D400058P	D400058P	D400058P	D400058P	D400058P	D400058P	1
12	Remote Control Receiver	RCB-R	RCB-R	RCB-R	RCB-R	RCB-R	RCB-R	RCB-R	1
xxx	Glass Burner Media (not shown)	G100030	G100030	G100030	G100030	G100030	G100030	G100030	N/A
xxx	Top Media (many available)	xxx	xxx	xxx	xxx	xxx	xxx	xxx	N/A
<i>NOTE: Specifications, finishes and dimensions are subject to change!</i>									

# INSTALLATION RECORD

The installer should complete the form below that describes the details of the installation. Having this written record of installation information available will greatly expedite trouble-shooting should any problem arise with your fireplace. The installer should keep a duplicate of this form for their records. Accurate completion of this form is required for warranty coverage and for any technical support by Woodbridge Fireplace.

<b>Date Purchased:</b>
<b>Purchaser/Dealer:</b>
<b>Installer:</b>
<b>Fireplace S/N on product ID tag:</b>
<b>Date Installed:</b>

**FUEL:**       Natural Gas                       Propane

Inlet Pressure Measured After Installation:	<i>In. W.C.</i>
Manifold Pressure Measured After Installation:	
High Fire:	<i>In. W.C.</i>
Low Fire:	<i>In. W.C.</i>

**VENTING:**

Please Verify The Brand And Model Of Venting Used:			
Vent Termination (Cap):	<input type="radio"/> Horizontal	<input type="radio"/> Vertical	<input type="radio"/> Snorkel
Vent Cap Model No:			

**CONFIGURATION:**

**Vent Configuration Sketch Required Below:**

Total Horizontal Run:	<i>Feet/Inches</i>	
Total Vertical Run:	<i>Feet/Inches</i>	
Quantity 90° Elbows:		
Quantity 45° Elbows:		
<b>ALTITUDE:</b> <i>Feet Above Sea Level</i>		
Was Stove Derated?	<input type="radio"/> Yes <input type="radio"/> No	
If Yes To What Orifice Size?		
Unusual Structure Near Vent?		
<input type="radio"/> Inside Corner <input type="radio"/> Trees/Shrubs <input type="radio"/> Other		
Termination: <i>(Please Describe)</i>		
Prevalent Wind Conditions?		
Other Installation Notes:		

# WARRANTY INFORMATION

KEEP THIS FOR WARRANTY

Model _____
Serial No. _____
Date Purchased _____

Always specify model and serial numbers when communicating with the factory.

## LIMITED LIFETIME WARRANTY

The following components are warranted for life to the original owner, subject to proof of purchase:  
Burner Assembly.

### BASIC WARRANTY

Woodbridge Fireplace Inc. warrants the components and materials in your appliance to be free from manufacturing and material defects for a period of two years from date of installation. After installation, if any of the components manufactured by Woodbridge Fireplace in the appliance are found to be defective in materials or workmanship, Woodbridge Fireplace will, at its option, replace or repair the defective components at no charge to the original owner. Woodbridge Fireplace will also pay for reasonable labor cost incurred in replacing or repairing such components for a period of two years from date of installation. Any products presented for warranty repair must be accompanied by a dated proof of purchase.

This Limited Lifetime Warranty will be void if the appliance is not installed by a qualified installer in accordance with installation instructions. The Limited Lifetime Warranty will also be void if the appliance is not operated and maintained according to the operating instructions supplied with the appliance, and does not extend to (1) firebox/burner assembly damaged by accident, neglect, misuse, abuse, alterations, negligence of others, including the installation thereof by unqualified installers, (2) the costs of removal, reinstallation or transportation of defective parts on the appliance, or (3) incidental or consequential damage. All service work must be performed by an authorized service representative.

This warranty is expressly in lieu of other warranties, express or implied, including the warranty of merchantability of fitness for purpose and of all other obligations or liabilities. Woodbridge Fireplace does not assume for it any other obligations or liabilities in connection with sale or use of the appliance. In states that do not allow limitations on how long an implied warranty lasts, or do not allow exclusion of indirect damage, those limitations of exclusions may not apply to you. You may also have additional right not covered in the Limited Lifetime Warranty. Woodbridge Fireplace reserves the right to investigate any and all the claims against this Warranty and decide upon method of settlement. For information about this warranty contact:

**Woodbridge Fireplace Inc.**  
**1305 Meyerside Dr., Mississauga**  
**Ontario, Canada L5T 1C9**  
Tel.: 1-905-564-3001  
[www.woodbridgedealer.com](http://www.woodbridgedealer.com)