

Woodbridge Fireplace Inc.



Indoor/Outdoor Gas Fireplace with electronic ignition system

Models: SV-36, 48, 60, 72 (N/P)

OWNER'S OPERATION AND INSTALLATION MANUAL



We recommend that our products be installed and serviced by professionals who are certified in the U.S. by NFI (National Fireplace Institute).



Report # 0401GF006S

Complies with

ANSI Z21.97 - CSA 2.41-2017 "Outdoor Decorative Gas Appliances",
CSA 2.17-2017 "Gas-Fired Appliances for Use at High Altitudes"



DANGER

If you smell gas:

1. Shut off gas to appliance.
2. Extinguish any open flame.
3. If odor continues, keep away from the appliance and immediately call your gas supplier or fire department.



WARNING

Improper installation, adjustment, alteration, service or maintenance can cause injury or property damage. Read the installation, operating and maintenance instructions thoroughly before installing or servicing this equipment.



WARNING

1. Do not store or use gasoline or other flammable vapors and liquids in the vicinity of this or any other appliance.
2. A propane cylinder not connected for use shall not be stored in the vicinity of this or any other appliance.



DANGER



CARBON MONOXIDE HAZARD

This appliance can produce carbon monoxide which has no odor. Using it in an enclosed space can kill you. Never use this appliance in an enclosed space as a camper, tent, car or home



WARNING: For Outdoor Use Only

INSTALLER: Leave this manual with the appliance. **CONSUMER:** Retain this manual for future reference.

Version française de ce manuel est disponible à partir du site WEB : www.woodbridgedealer.com
French version of this Owners Manual is available at www.woodbridgedealer.com

TABLE OF CONTENTS

Safety Information	3
Local Codes.....	4
Fireplace Specifications, Approvals	5
Installation.....	7
Clearance to Combustibles	9
Framing	11
Installation on outdoor side and drainage	12
Installation on indoor side	15
Electrical Wiring	16
Gas Connection	17
Checking Gas Pressure	18
Placing Glass Panel and Media Tray	20
Safety screen installation	21
Lighting Instructions	23
Operating Instructions	23
To Turn Off Gas to Appliance	23
Inspecting Burners	24
Cleaning and Maintenance	25
Troubleshooting	26
Proflame Control Wiring Diagram	30
Illustrated Parts Breakdown, Parts List.....	31
Warranty Information	Back Cover

SAFETY INFORMATION

⚠ WARNING: This product contains and/or generates chemicals known to the state of California to cause cancer or birth defects or other reproductive harm.

IMPORTANT: Read this owner's manual carefully and completely before trying to assemble, operate or service this heater. Improper use of this heater can cause serious injury or death from burns, fire, explosion, electrical shock and carbon monoxide poisoning.

⚠ DANGER: Carbon monoxide poisoning may lead to death!

Carbon Monoxide Poisoning: Early signs of carbon monoxide poisoning resemble the flu, with headaches, dizziness or nausea. If you have these signs, the heater may not be working properly. **Get fresh air at once!** Have heater serviced. Some people are more affected by carbon monoxide than others. These include pregnant women, people with heart or lung disease or anemia, those under the influence of alcohol and those at high altitudes.

Natural and Propane Gas: Natural and propane gases are odorless. An odor-making agent is added to the gas. The odor helps you detect a gas leak. However, the odor added to the gas can fade. Gas may be present even though no odor exists.

Make certain you read and understand all warnings. Keep this manual for reference. It is your guide to safe and proper operation of this heater.

⚠ WARNING: Any change to this heater or its controls can be dangerous.

⚠ WARNING: Do not use a blower insert, heat exchanger insert or other accessory not approved for use with this heater.

⚠ WARNING: Do not allow fans to blow directly into the fireplace. Avoid any drafts that alter burner flame patterns. Ceiling fans can create drafts that alter burner flame patterns. Altered burner patterns can cause sooting.

Due to high temperatures, the appliance should be located out of traffic and away from furniture and draperies.

Do not place clothing or other flammable material on or near the appliance. Never place any objects on the heater.

Fireplace front becomes very hot when running fireplace. Keep children and adults away from hot surfaces to avoid burns or clothing ignition. Fireplace will remain hot for a time after shutdown. Allow surfaces to cool before touching.

Carefully supervise young children when they are in the room with fireplace. When using the optional hand-held remote accessory, keep selector switch inside firebox in the OFF position to prevent children from turning on burners with remote.

Keep the appliance area clear and free from combustible materials, gasoline and other flammable vapors and liquids.

SAFETY INFORMATION

Continued



1. This appliance is only for use with the type of gas indicated on the rating plate. This appliance is not convertible for use with other gases.
2. Do not place propane supply tank(s) inside any structure. Locate propane supply tank(s) outdoors (propane units only).
3. If you smell gas
 - shut off gas supply
 - do not try to light any appliance
 - do not touch any electrical switch; do not use any phone in your building
 - immediately call your gas supplier from a neighbor's phone. Follow the gas supplier's instructions
 - if you cannot reach your gas supplier, call the fire department
4. Do not use this fireplace as a wood-burning fireplace.
5. Children and adults should be alerted to the hazards of high surface temperatures and should stay away to avoid burns or clothing ignition.
11. Turn fireplace off and let cool before servicing. Only a qualified service person should service and repair fireplace.
12. Operating fireplace above elevations of 4,500 feet could cause pilot outage.
13. To prevent performance problems in propane units, do not use propane fuel tanks of less than 100 lbs. capacity (propane units only).
14. Provide adequate clearances around air openings.

Keep the appliance area clear and free from combustible materials, gasoline and other flammable vapors and liquids.

6. To prevent the creation of soot, follow the instructions in *Cleaning and Maintenance* section.
7. Before using furniture polish, wax, carpet cleaner or similar products, turn heater off. If heated, the vapors from these products may create a white powder residue within burner box or on adjacent walls or furniture.
8. Do not run fireplace
 - where flammable liquids or vapors are used or stored
 - under dusty conditions
9. Do not use this fireplace to cook food or burn paper or other objects.
10. Do not use fireplace if any part has been exposed to or under water. Immediately call a qualified service technician to inspect the fireplace and to replace any part of the control system and any gas control which has been under water.

LOCAL CODES

Install and use fireplace with care. When an appliance is for connection to a fixed piping system, the installation must conform with local codes, or in the absence of local codes, with *The National Fuel Gas Code ANSI Z223.1/NFPA 54**, *International Fuel Gas Code*, *Natural Gas and Propane Installation Code*, *CSA B149.1*, or *Propane Storage and Handling Code*, *B149.2*, as applicable.

*Available from:

American National Standards Institute, Inc.
1430 Broadway
New York, NY 10018
National Fire Protection Association, Inc.
Batterymarch Park
Quincy, MA 02269

State of Massachusetts: The installation must be made by a licensed plumber or gas fitter in the Commonwealth of Massachusetts.

Sellers of unvented propane or natural gas-fired supplemental room heaters shall provide to each purchaser a copy of 527 CMR 30 upon sale of the unit.

Vent-free gas products are prohibited for bedroom and bathroom installation in the Commonwealth of Massachusetts.

FIREPLACE SPECIFICATIONS

DIMENSIONS

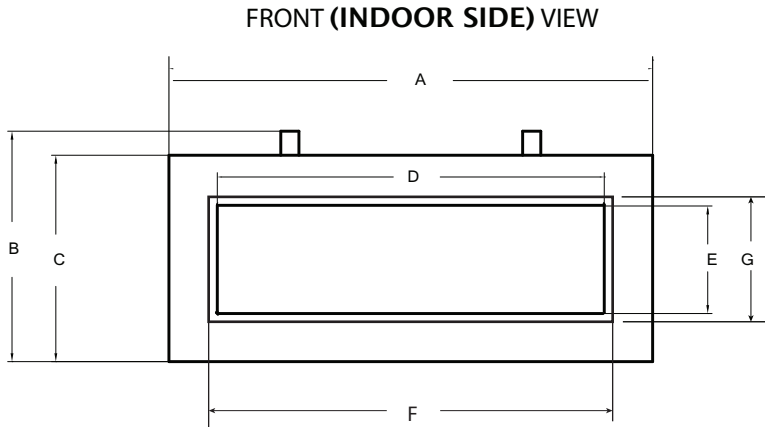
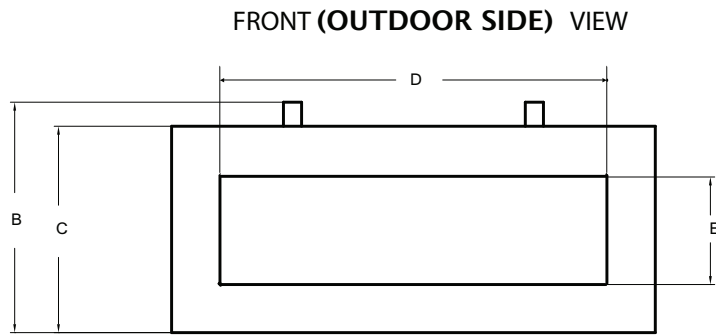

RIGHT SIDE VIEW

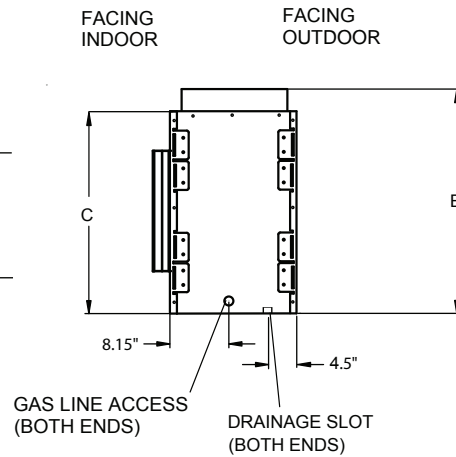

TOP VIEW

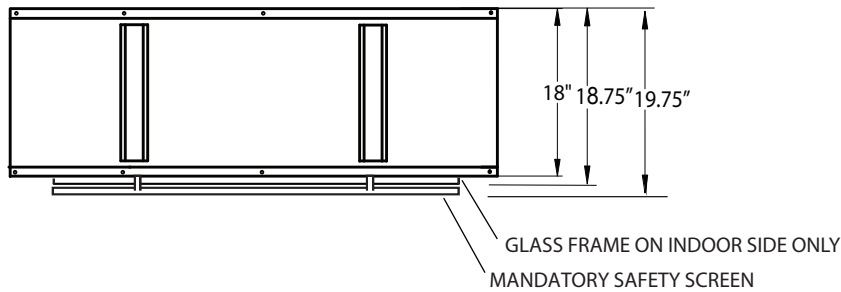

	SV-36	SV-48	SV-60	SV-72
A	48"	60"	72"	84"
B	33.75"	29.75"	31.75"	31.75"
C	29.75"	25.75"	25.75"	25.75"
D	36"	48"	60"	72"
E	17.31"	13.75"	13.75"	13.75"
F	38.38"	50.38"	62.38"	74.38"
G	19.56"	16"	16"	16"

SPECIFICATIONS

Parameter / Model	SV-36N	SV-48N	SV-60N	SV-72N
Gas Type	Natural	Natural	Natural	Natural
S.I.T. Control Valve Model	880.001	880.001	880.001	880.001
Ignition	Electronic	Electronic	Electronic	Electronic
Manifold Pressure	3.5" w.c.	3.5" w.c.	3.5" w.c.	3.5" w.c.
Inlet Gas Pressure, MAX	10.5" w.c.	10.5" w.c.	10.5" w.c.	10.5"
Inlet Gas Pressure, MIN	5.0" w.c.	5.0" w.c.	5.0" w.c.	5.0" w.c.
Orifice Size (Q-ty per unit)	#34 (1)	#21 (1)	#30 (2)	#27 (2)
Heat Output, Btu/h	40,000	60,000	75,000	90,000
Shipping Weight, Lbs	135	155	175	195

Parameter / Model	SV-36P	SV-48P	SV-60P	SV-72P
Gas Type	Propane	Propane	Propane	Propane
S.I.T. Control Valve Model	880.002	880.002	880.002	880.002
Ignition	Electronic	Electronic	Electronic	Electronic
Manifold Pressure	10.0" w.c.	10.0" w.c.	10.0" w.c.	10.0" w.c.
Inlet Gas Pressure, MAX	13.0" w.c.	13.0" w.c.	13.0" w.c.	13.0" w.c.
Inlet Gas Pressure, MIN	11.0" w.c.	11.0" w.c.	11.0" w.c.	11.0" w.c.
Orifice Size (Q-ty per unit)	#49 (1)	#41 (1)	#48 (2)	#45 (2)
Heat Output, Btu/h	38,000	56,000	75,000	90,000
Shipping Weight, Lbs	135	155	175	195

APPROVALS

These appliances have been tested and listed by OMNI-Test Laboratories Inc. (Report # 0401GF006S) to:

ANSI Z21.97 - CSA 2.41-2017 "Outdoor Decorative Gas Appliances",
 CSA 2.17-2017 "Gas-Fired Appliances for Use at High Altitudes"

These appliances have been tested by INTERTEK (Report # 103178379TOR-001) to:

ASTM E283-04 "Air Leakage", ASTM E331-00 "Water Penetration", ASTM E330-14 "Structural Performance".

INSTALLATION

INSTALLING GAS PIPING TO FIREPLACE LOCATION

⚠ WARNING: This appliance requires a 1/2" NPT (National Pipe Thread) inlet connection to the pressure regulator.

⚠ WARNING: A qualified service person must connect fireplace to gas supply. Follow all local codes.

⚠ CAUTION: Never connect propane fireplace directly to the propane supply. This fireplace requires an external regulator (not supplied). Install the external regulator between the fireplace and propane supply.

IMPORTANT: Allow for a minimum space of 1/2" x 26" for air flow to the front louvers of the fireplace from below when covering the face.

NOTICE: Surface temperatures of adjacent walls and mantels become hot during operation. Walls and mantels above the firebox may become hot to the touch. If installed properly, these temperatures meet the requirement of the national product standard. Follow all minimum clearances shown in this manual.

LOCATING YOUR OUTDOOR GAS FIREPLACE

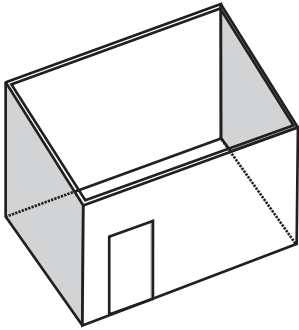

- 1) When selecting a location for your fireplace, ensure that the clearances are met.
- 2) This appliance must be installed in an open-air situation with natural ventilation, without stagnant areas, where gas leakage and products of combustion are rapidly dispersed by wind and natural convection.
- 3) Certain materials or items, when placed under or near the appliance, will be subjected to radiant heat and could become damaged.
- 4) Typically an outdoor space is not enclosed but, any enclosure in which the appliance is used shall comply with one of the following:

An enclosure with walls on all sides, but at least one permanent opening at ground level and no overhead cover.

Within a partial enclosure that includes an overhead cover and no more that two walls.

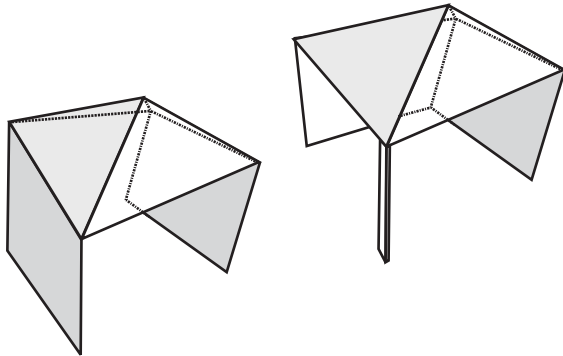

Within a partial enclosure that includes an overhead cover and more than two walls, the following shall apply:

- At least 25% of the total wall area is completely open, and
- At least 30% of the remaining wall area is open and unrestricted

30% or more in total of the remaining wall area is open and unrestricted.

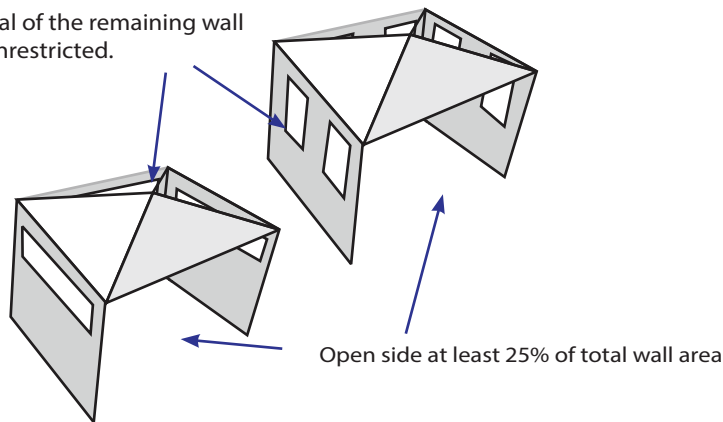

IMPORTANT: Minimum ambient air temperature for the fireplace operation is 0°C (32°F)

Continued on next page

INSTALLATION ON OUTDOOR (NO GLASS) SIDE

CLEARANCES TO COMBUSTIBLES

WARNING

Follow these instructions carefully to ensure safe installation. Failure to follow instructions exactly can create a fire hazard.

IMPORTANT:

The fireplace faces may be completely covered with any non-combustible material on both sides (refer to pages 10-15). Total thickness of covering material should not exceed 1.5".

Clearance to Combustibles

Sides	0" (0 mm)
Floor	*
Front	36" (915 mm)
Standoff	0" (0 mm)

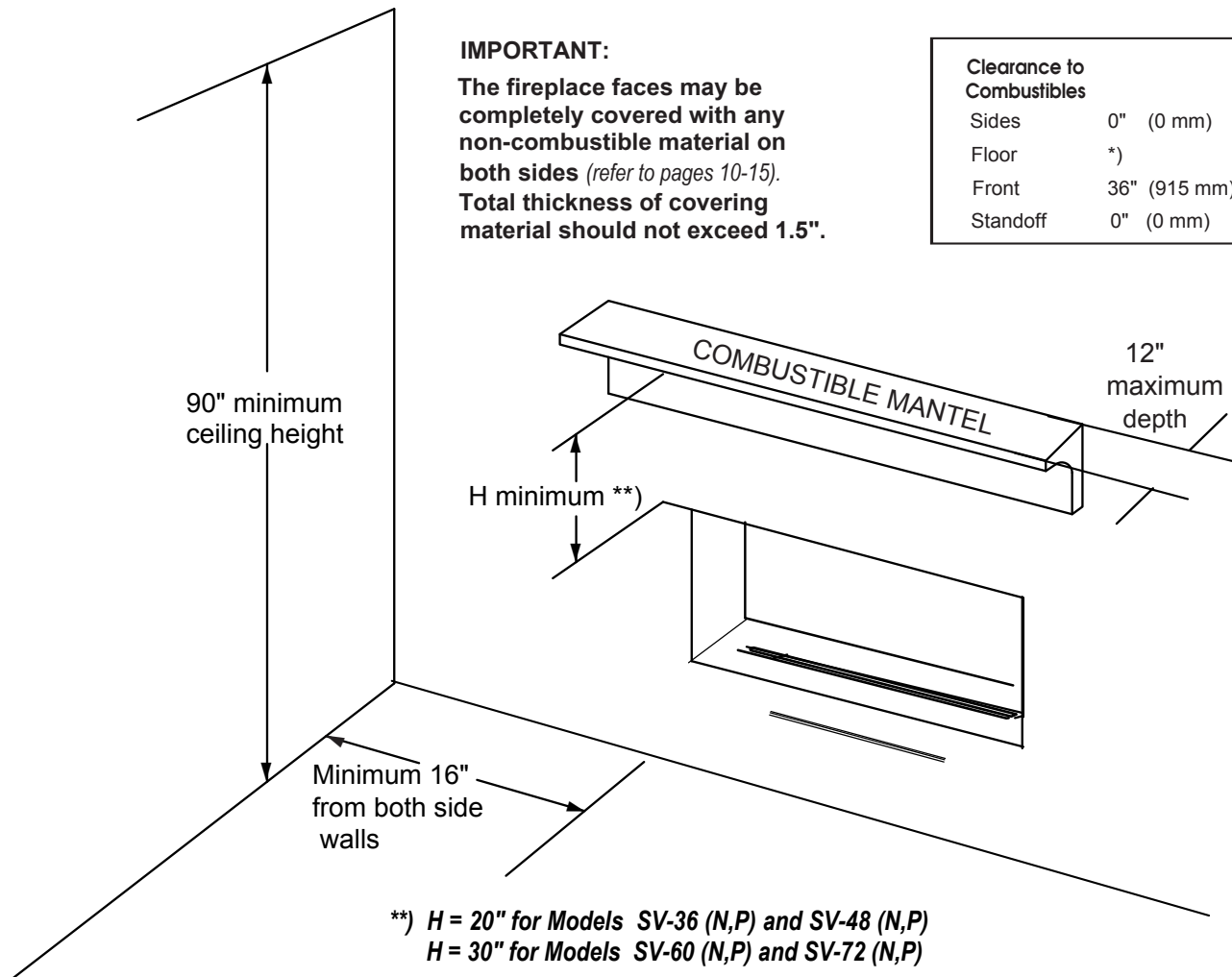

MANTEL CLEARANCES

NOTE: The combustible area above the facing must not protrude more than $\frac{3}{4}$ " from the facing. If it does, it is considered a mantel and must meet the mantel requirements listed in this manual.

*) IMPORTANT:

Floor must be non-combustible. Otherwise a minimum 1" thick cement board must be placed under the fireplace.

INSTALLATION ON INDOOR (GLASS) SIDE

CLEARANCES TO COMBUSTIBLES

WARNING

Follow these instructions carefully to ensure safe installation. Failure to follow instructions exactly can create a fire hazard.

IMPORTANT:

The fireplace face may be covered with non-combustible material with at least 1/8" gap between the finishing material and fireplace face to allow heat expansion for the fireplace face.

The opening in finishing non-combustible material must be at least 2" wider and 2" taller than outside measurements for the glass door frame to allow removal and install the glass frame and safety screen from indoor side of the fireplace (see p.15). Total thickness of covering material should not exceed 1.5".

Clearance to Combustibles ON INDOOR SIDE ONLY		
Top	6.25"	(159 mm)
To top standoff	0"	(0 mm)
Sides	1"	(26 mm)
To side standoffs	0"	(0 mm)
Back	1.5"	(38 mm)
To back standoffs	0"	(0 mm)
Front	36"	(915 mm)

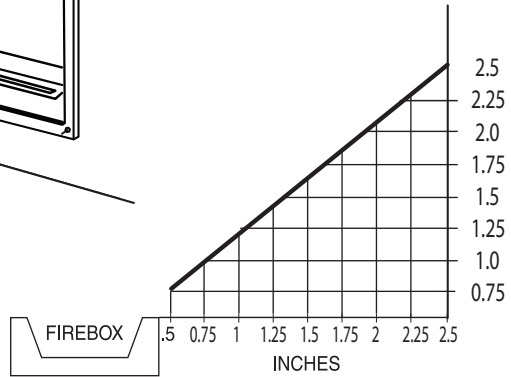
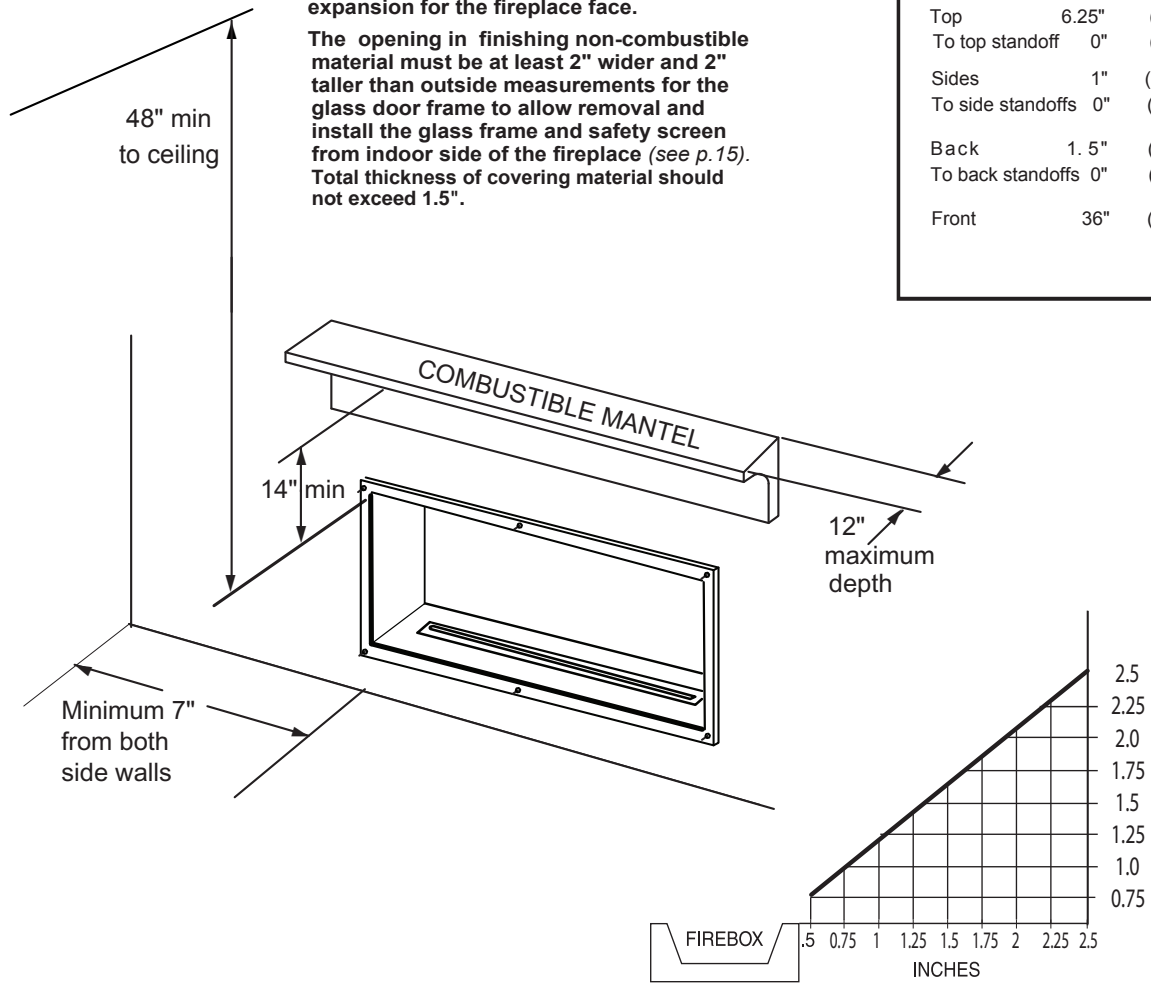

*Minimum 7 inches from Side Wall to Fireplace opening

Side Clearance Chart

MANTEL CLEARANCES

NOTE: The combustible area above the facing must not protrude more than 3/4" from the facing. If it does, it is considered a mantel and must meet the mantel requirements listed in this manual.

*) IMPORTANT:

Floor must be non-combustible. Otherwise a minimum 1" thick cement board must be placed under the fireplace.

FRAMING DIMENSIONS

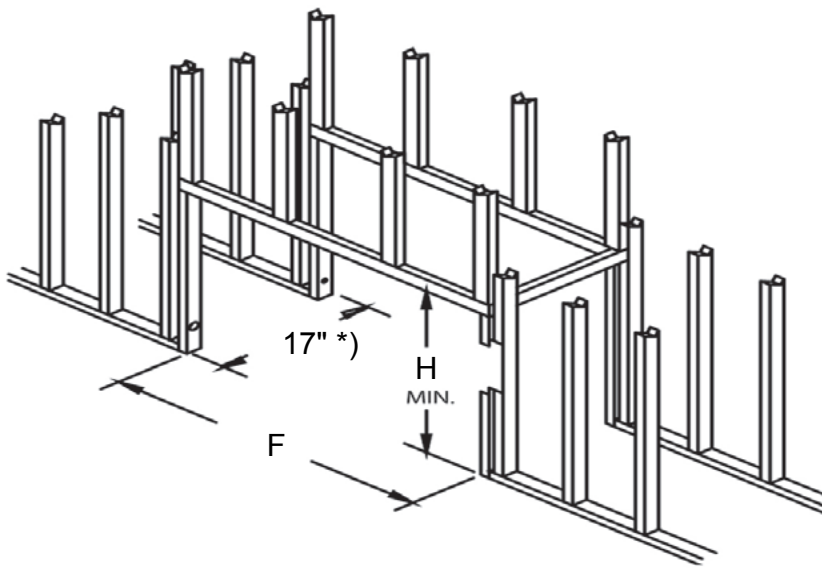
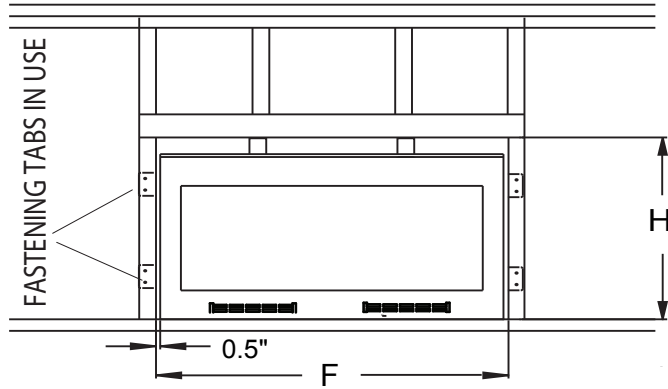

SV-36 (N,P) SV-48(N,P) SV-60(N,P) SV-72(N,P)

	SV-36 (N,P)	SV-48(N,P)	SV-60(N,P)	SV-72(N,P)
F	49"	61"	73"	85"
H	34"	30"	32"	32"

*) PLEASE NOTE: Framing may need to be recessed from 3/4" to 1-1/2" depending on layers and type of facing material used during installation.

INSTALLATION ON OUTDOOR (NO GLASS) SIDE

FACING REQUIREMENTS ON OUTDOOR SIDE

MINIMUM NON COMBUSTIBLE MATERIAL AREA

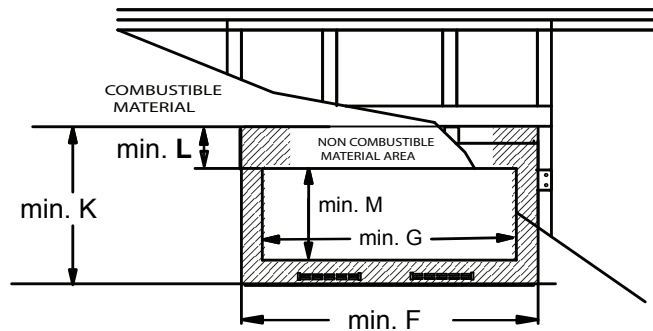

	SV-36 (N,P)	SV-48(N,P)	SV-60(N,P)	SV-72(N,P)
F	49"	61"	73"	85"
G	36.5"	48.5"	60.5"	72.5"
K	34"	30"	38"	38"
L	10"	10"	18"	18"
M	17.6"	14"	14"	14"

IMPORTANT: The fireplace face may be covered with non-combustible material with at least 1/8" gap between the finishing material and fireplace face to allow heat expansion for the fireplace face.

NOTE: For accessory safety screen attachment dimensions "M" and "G" need to be increased by 1" for proper clearance.

THREE WAYS TO ALLOW AIR FLOW TO FRONT AIR VENT

OPTION 1

FACING WITH ONE LAYER OF NON-COMBUSTIBLE MATERIAL

IE: DUROCK, CEMENT BOARD, GRANITE, MARBLE, STONE

Total thickness of covering material should not exceed 1.5".

OUTDOOR SIDE

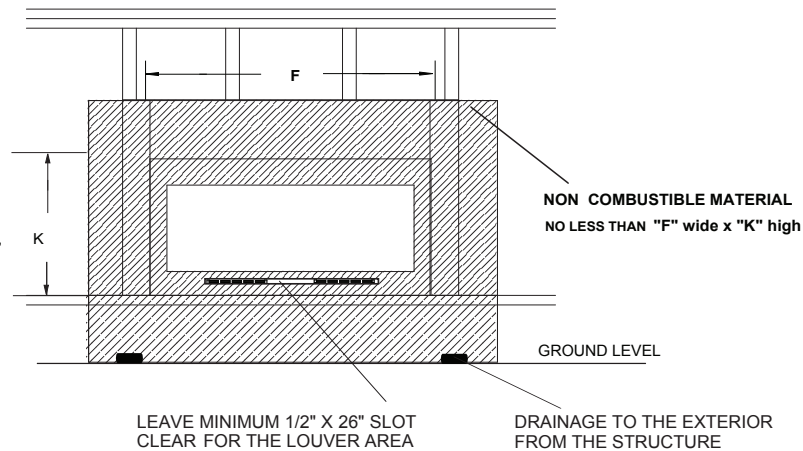

Figure 1.1 - Installation of facing materials (Case #1)

OPTION 2

FACING OUTDOOR SIDE WITH TWO LAYERS
OF NON-COMBUSTIBLE MATERIALS
IE: DUROCK, CEMENT BOARD, GRANITE, MARBLE, STONE

Total thickness of covering material should not exceed 1.5".

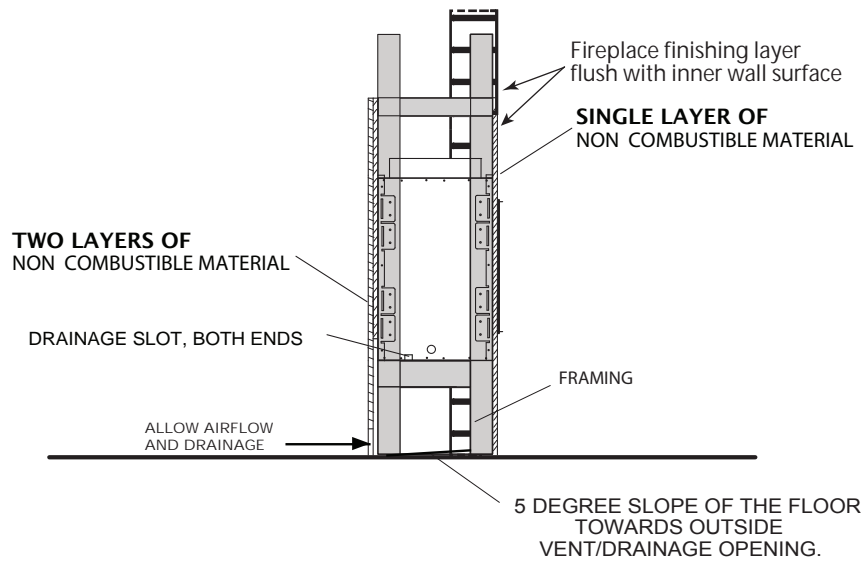
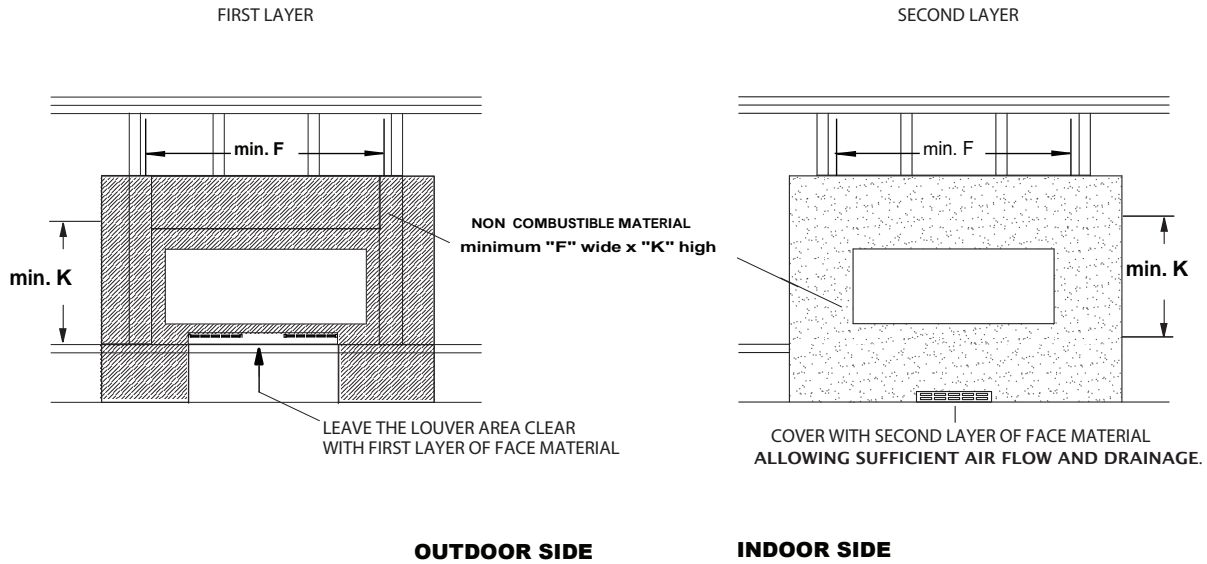

Figure 1.2 - Installation of facing materials (Case #2)

OPTION 3

FACING OUTDOOR SIDE WITH THICK LAYER OF NON-COMBUSTIBLE MATERIAL ALLOWING AIR FLOW FROM BEHIND SURROUND

Total thickness of covering material should not exceed 1.5".

VIEW FROM BACK OF SURROUND

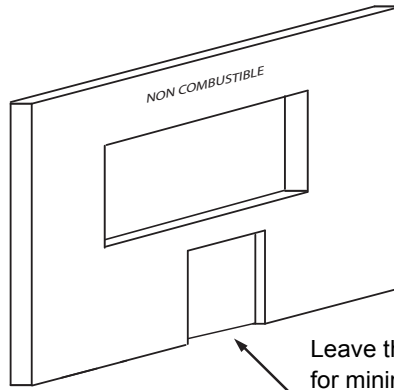

Leave the louver area clear for minimum 13 sq. inches to allow sufficient air flow and drainage.

FRONT VIEW

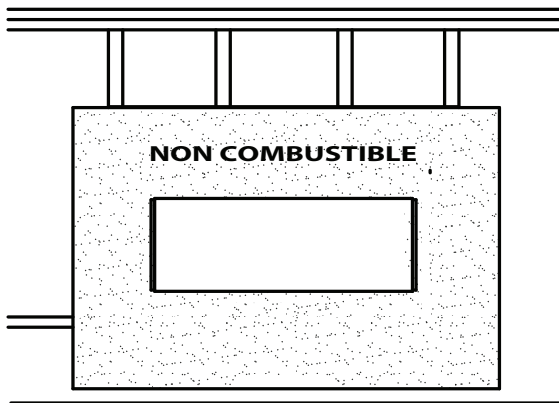

SIDE VIEW

OUTDOOR SIDE

INDOOR SIDE

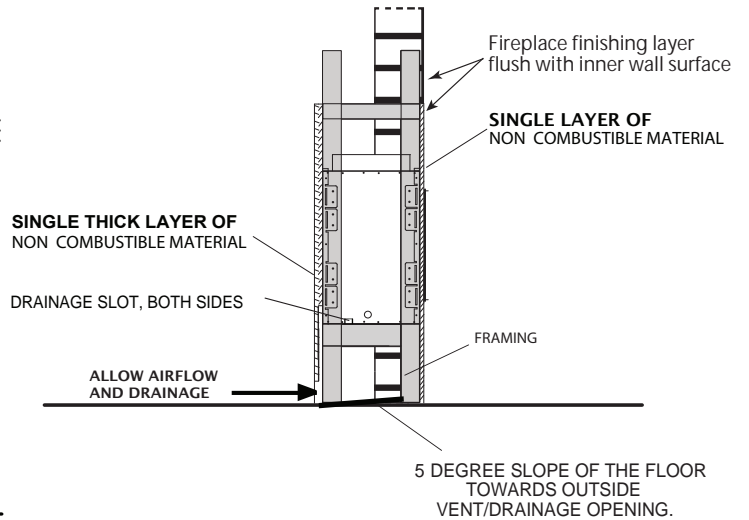
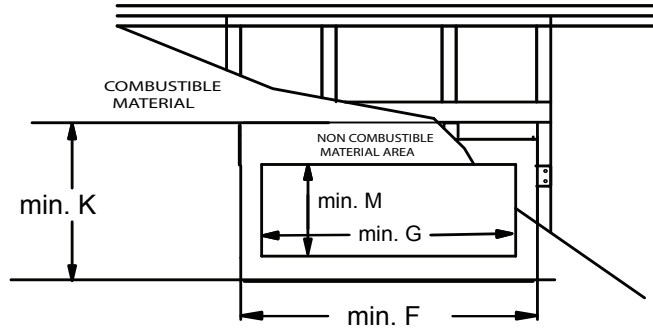

Figure 1.3 - Installation of facing materials (Case #3)

IMPORTANT: Asure proper provision for drainage is incorporated in the design of the finishing materials of the structure exterior.

INSTALLATION ON INDOOR (GLASS) SIDE

FACING REQUIREMENTS ON INDOOR SIDE MINIMUM NON COMBUSTIBLE MATERIAL AREA



	SV-36 (N,P)	SV-48(N,P)	SV-60(N,P)	SV-72(N,P)
F	49"	61"	73"	85"
G	4"	"	"	"
K	34"	30"	38"	38"
M	1 1/8"	1 1/8"	1 1/8"	1 1/8"

NON COMBUSTIBLE MATERIAL
NO LESS THAN "F" wide x "K" high

IMPORTANT:

The fireplace face may be covered with non-combustible material with at least 1/8" gap between the finishing material and fireplace face to allow heat expansion for the fireplace face.

The opening in finishing non-combustible material must be at least 8" wider and 8" taller than outside measurements for the glass door frame to allow removal and install the glass frame and safety screen from indoor side of the fireplace.

Total thickness of covering material should not exceed 1.5".

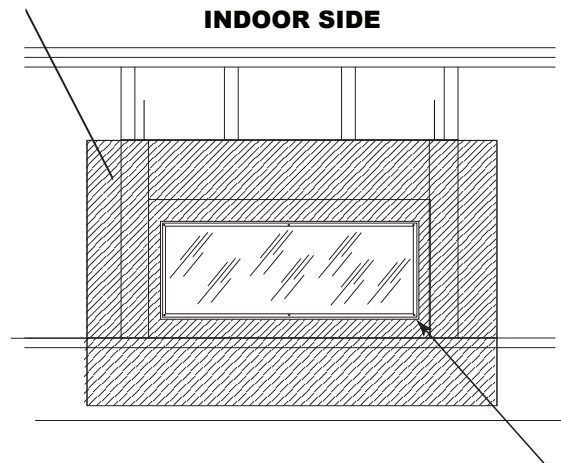

LEAVE MINIMUM 1/8" GAP BETWEEN GLASS FRAME AND FACING MATERIAL ALL WAY AROUND TO ALLOW GLASS FRAME REMOVAL.

Figure 2 - Installation of facing materials on indoor side

ELECTRICAL WIRING INSTALLATION

ELECTRICAL WIRING

This fireplace requires 110V AC electrical supply for normal operation in order to power up 7V DC adapter which is required to operate Remote Control. However, during power outage situation, its electronic system (DFC board) can be temporarily powered with 6V DC battery pack (4 AA batteries).

WARNING

Electrical connections should only be performed by a qualified, licensed electrician. Main power must be off when connecting to main electrical power supply or performing service. All wiring shall be in compliance with all local, city, and state codes. The appliance, when installed, must be electrically grounded in accordance with local codes, or in the absence of local codes, with the *National Electrical Code ANSI/ NFPA 70 (latest edition)* and *Canadian Electrical Code, CSA C22.1*.

CAUTION

Label all wires before disconnecting when servicing controls. Wiring errors can cause improper and dangerous operation.

INSTALLATION

Continued

WARNING: Never connect natural gas fireplace to private (non-utility) gas wells. This gas is commonly known as wellhead gas.

Installation Items Needed

Before installing fireplace, make sure you have the items listed below.

- external regulator for propane unit only (supplied by installer)
- piping (check local codes)
- sealant (resistant to propane gas)
- equipment shutoff valve *
- test gauge connection *
- sediment trap (optional)
- tee joint
- pipe wrench
- approved flexible gas line with gas connector (if allowed by local codes) (not provided)

A CSA design-certified equipment shutoff valve with 1/8" NPT tap is an acceptable alternative to test gauge connection. Purchase the optional CSA design-certified equipment shutoff valve from your dealer.

For propane units, the installer must supply an external regulator. The external regulator will reduce incoming gas pressure. You must reduce incoming gas pressure to between 11 and 14 inches of water. If you do not reduce incoming gas pressure, heater regulator damage could occur. Install external regulator with the vent pointing down as shown in Figure 4. Pointing the vent down protects it from freezing rain or sleet.

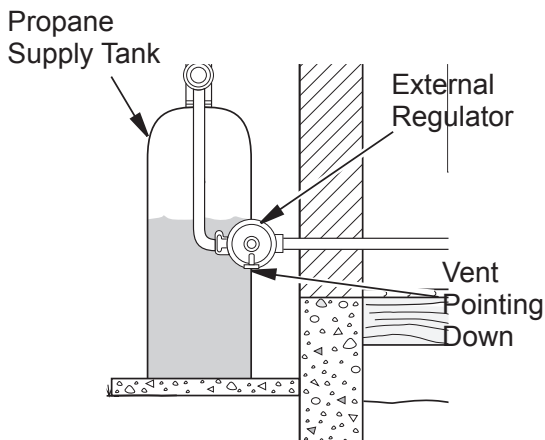

Figure 3 - External Regulator With Vent Pointing Down

CAUTION: Use only new, black iron or steel pipe. Internally-tinned copper tubing may be used in certain areas. Check your local codes. Use pipe of 1/2" diameter or greater to allow proper gas volume to fireplace. If pipe is too small, undue loss of volume will occur.

Installation must include an equipment shutoff valve, union and plugged 1/8" NPT tap. Locate NPT tap within reach for test gauge hook up. NPT tap must be upstream from fireplace □

SHUTOFF VALVE

IMPORTANT: Install equipment shutoff valve in an accessible location. The equipment shutoff valve is for turning on or shutting off the gas to the appliance.

Check your building codes for any special requirements for locating equipment shutoff valve to fireplaces.

Apply pipe joint sealant lightly to male NPT threads. This will prevent excess sealant from going into pipe. Excess sealant in pipe could result in clogged fireplace valves. Never use sealant on flare threads.

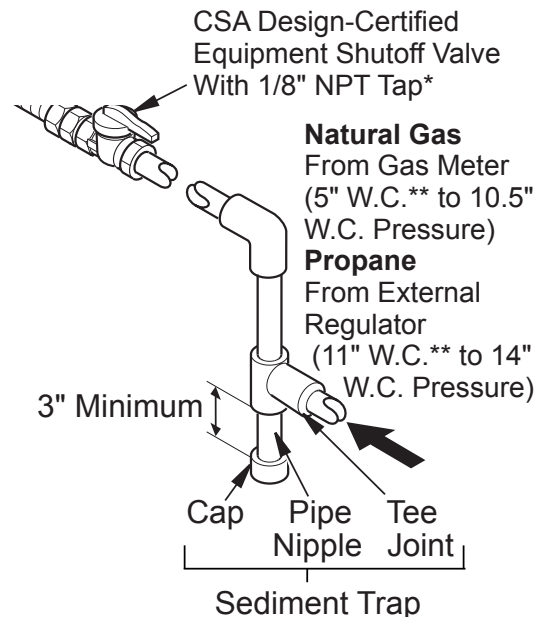

Figure 4 - Gas Connection

* Purchase the optional CSA design-certified equipment shutoff valve from your dealer.

** Minimum inlet pressure for purpose of input adjustment.

INSTALLATION

Continued

⚠ WARNING: Use pipe joint sealant that is resistant to liquid petroleum (propane) gas.

We recommend that you install a sediment trap in supply line as shown in Figure 4, page 19. Locate sediment trap where it is within reach for cleaning. Install in piping system between fuel supply and fireplace. Locate sediment trap where trapped matter is not likely to freeze. A sediment trap traps moisture and contaminants. This keeps them from going into fireplace gas controls. If sediment trap is not installed or is installed wrong, fireplace may not run properly.

CONNECTING FIREPLACE TO GAS SUPPLY

1. Remove access panel.
2. Route gas line (provided by installer) from equipment shutoff valve to fireplace. Route flexible gas supply line through one of the access holes.
3. Attach the flexible gas line to gas supply as per Figure 5. Check tightness of flexible gas line attached to gas regulator of fireplace and check all gas connections for leaks (see *Checking Gas Connections*, page 21).

NOTICE: Most building codes do not permit concealed gas connections. A flexible gas line is provided to allow accessibility from the fireplace (see Figure 5). The flexible gas supply line connection to the equipment shutoff valve should be accessible.

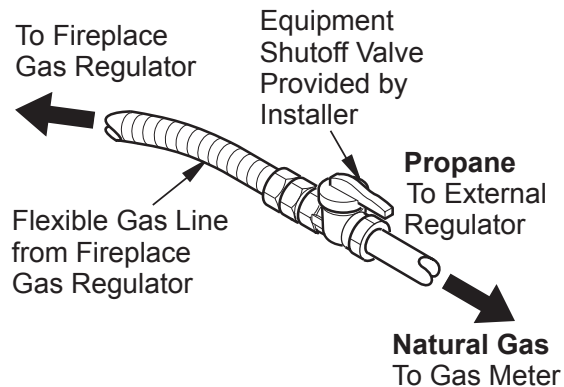
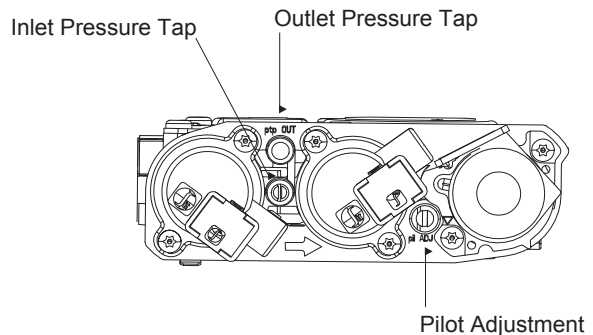

Figure 5 - Attaching Flexible Gas Lines Together

CHECKING GAS PRESSURE

1. Check gas type. The gas supply must be the same as stated on the appliance's rating decal. If the gas supply is different from the fireplace, STOP! Do not install the appliance. Contact your dealer immediately.
2. To ease installation, a 30" (mm) flex line with manual shut-off valve has been provided with on this appliance. Install and attach 1/2" gas line onto shut-off valve.
3. After completing gas line connection, purge air from gas line and test all gas joints from the gas meter to the fireplace for leaks. Use a solution of 50/50 water and soap or a gas sniffer.
4. To check gas pressures at the valve, turn captured screw counter clockwise 2 or 3 turns and then place tubing to pressure gauge over test point.

Turn unit to high. After taking pressure reading, be sure and turn captured screw clockwise firmly to reseat. Do not overtorque. Check test points for gas leaks!



WARNING

Do not use open flame to check for gas leaks.

INSTALLATION

Continued

CHECKING GAS CONNECTIONS

⚠ WARNING: Test all gas piping and connections, internal and external to unit, for leaks after installing or servicing. Correct all leaks at once.

⚠ WARNING: Never use an open flame to check for a leak. Apply a noncorrosive leak detection fluid to all joints. Bubbles forming show a leak. Correct all leaks at once.

⚠ CAUTION: Make sure external regulator has been installed between propane supply and fireplace. See guidelines under *Connecting Fireplace to Gas Supply*.

PRESSURE TESTING GAS SUPPLY PIPING SYSTEM

Test Pressures In Excess Of 1/2 PSIG (3.5 kPa)

1. Disconnect fireplace with its main gas valve (control valve) and equipment shutoff valve from gas supply piping system. Pressures in excess of 1/2 psig will damage fireplace regulator.
2. Cap off open end of gas pipe where equipment shutoff valve was connected.
3. Pressurize supply piping system by either opening propane supply tank valve for propane gas or opening main gas valve located on or near gas meter for natural gas or using compressed air.
4. Check all joints of gas supply piping system. Apply noncorrosive leak detection fluid to all joints. Bubbles forming show a leak.
5. Correct all leaks at once.
6. Reconnect fireplace and equipment shutoff valve to gas supply. Check reconnected fittings for leaks.

Test Pressures Equal To or Less Than 1/2 PSIG (3.5 kPa)

1. Close equipment shutoff valve (see Figure 6).
2. Pressurize supply piping system by either opening propane supply tank valve for propane gas or opening main gas valve located on or near gas meter for natural gas or using compressed air.
3. Check all joints from gas meter to equipment shutoff valve for natural gas or propane supply to equipment shutoff valve for propane. Apply noncorrosive leak detection fluid to all joints. Bubbles forming shows a leak.

PRESSURE TESTING FIREPLACE GAS CONNECTIONS

1. Open equipment shut off valve (see Figure 6).
2. Open main gas valve located on or near gas meter for natural gas or open propane supply tank valve.

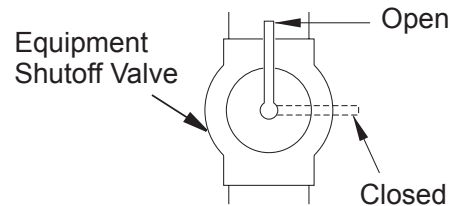

Figure 6 - Equipment Shutoff Valve

3. Make sure control knob of fireplace is in the OFF position.
4. Check all joints from equipment shutoff valve to gas control valve. Apply non-corrosive leak detection fluid to all joints. Bubbles forming detects leak.
5. Correct all leaks at once.
6. Light fireplace (see *Operating Fireplace*, page 19. Check all other internal joints for leaks.
7. Turn off fireplace (see *To Turn Off Gas to Appliance*).

MEDIA PLACEMENT

MEDIA AND GLASS PANEL PLACEMENT

WARNING

Do not operate the appliance without the burner being completely filled with glass media. Lighting the burner without the glass media will cause unsafe temperatures within the appliance.

1. Fill the burner tray completely with the supplied clear glass media.

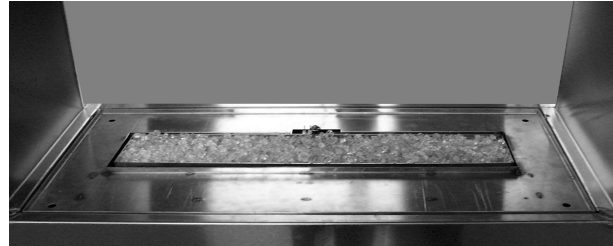

NOTE: Verify burner and remote control operation prior to installing the glass panel and media!

2. Locate the glass wind shield panel and slide down into the support brackets. Assure the panel is centered in the fireplace and the support brackets are fastened securely.



3. Fill the tray with the media supplied. Do not place this media on the burner or block air flow between the burner and the tray.



4. Evenly spread the media in the tray. Assure that loose pieces of glass are not blocking the pilot.

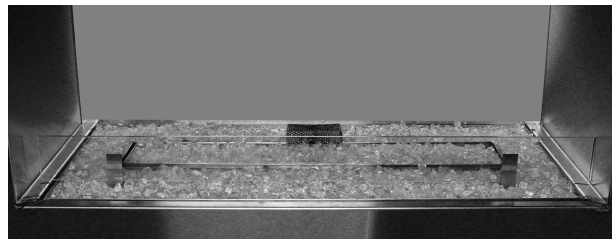

5. Install the glass frame assembly on the indoor side using hex nuts. Proceed with installation of the mandatory safety screen on the indoor (glass frame) side (see next page).



**MANDATORY SAFETY SCREEN INSTALLATION
ON INDOOR (GLASS FRAME) SIDE**

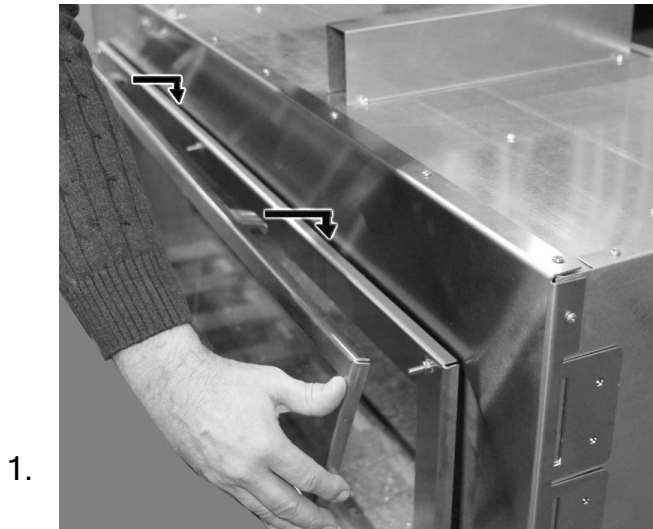

Hold the safety screen from the both sides and center it in front of the glass frame. Hook the upper tabs of the screen over the glass frame.



Assure that the upper part of the safety screen is centered and secured over the glass frame, then rotate the bottom of the screen towards the fireplace.



The safety screen is properly attached.

INSTALLATION

OPTIONAL SAFETY SCREEN INSTALLATION ON OUTDOOR (NO GLASS) SIDE

NOTE: Assure proper facing clearance as per page 12.



Position the upper end of the screen into the fireplace opening using the notches on the two upper side tabs.



While keeping the upper end notches intact with the fireplace face, rotate the bottom of the screen inward towards the fireplace. Stop at the position shown on the photograph.



While holding the screen with one hand, use your other hand to slightly bend the center tab up, then continue rotating the screen forward until the center tab can be latched into the slot as shown.

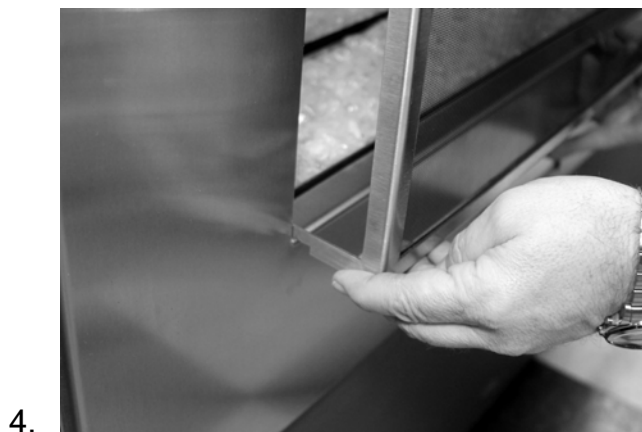

If necessary, slightly bend the left and right bottom tabs inward, to allow the screen to rest inside the fireplace opening.

LIGHTING INSTRUCTION

FOR YOUR SAFETY READ BEFORE OPERATING

WARNING: If you do not follow these instructions exactly, a fire or explosion may result causing property damage, personal injury, or loss of life.

- A. This appliance is equipped with an ignition device which automatically lights the pilot. Do not try to light the pilot by hand.
- B. **BEFORE OPERATING** smell all around the appliance area for gas. Be sure to smell next to the floor because some gas is heavier than air and will settle on the floor.
- WHAT TO DO IF YOU SMELL GAS**
- Do not try to light any appliance.
 - Do not touch any electric switch.
 - Do not use any phone in your building.
 - Immediately call your gas supplier from a neighbor's phone. Follow the gas supplier's instructions.
 - If you cannot reach your gas supplier, call the fire department.
- C. Main gas valve in this appliance is not serviceable and does not have any control knobs or switches to operate. Do not remove heat shields covering the valve and electronic devices; do not try to repair or modify the valve as it may result in a fire or explosion. Call a qualified service technician if you have any safety concerns.
- D. Do not use this appliance if any part of it has been under water. Immediately call a qualified service technician to inspect the appliance and to replace any part of the control system and any gas control which has been under water.

LIGHTING FOR THE FIRST TIME

DANGER: Never use an open flame to check for gas leak.

INITIAL LIGHTING

Purge air from the supply line as follows:

- Open main shutoff valve.
- Unscrew main pressure test point.
- Leave inlet test screw open until gas comes in.
- When gas is flowing, tighten inlet screw immediately.

LEAK TESTING

1. Follow the pipe from the gas supply line connection to the gas valve. Check connection for leaks with soap and water mixture.
2. Next check for gas leaks at the burner with soap and water mixture.
3. Check the pilot for gas leaks with soap and water mixture.

APPROVED LEAK TESTING METHOD

You may check for gas leaks with the following methods only:

- Soap and water solution
- An approved lead testing spray
- Electronic sniffer

WARNING: If using a soap and water solution to test for leaks, **DO NOT** spray solution onto electronic parts.

LIGHTING FOR THE FIRST TIME (Continued)

NOTE: Remove any excessive pipe compound from the connections. Excessive pipe compound can set off electronic sniffers.

Check for gas leaks in each of the following locations:

- Pipe from the gas supply line connection to the gas valve
- Burner connections, pilot
- All joints on valve and control body
- Field made joints / gas shutoff valve
- Factory made joints, each joint and connection

TO TURN OFF GAS TO APPLIANCE

1. Turn off all electric power to the appliance if service is to be performed. Unplug 7V DC adapter from the power outlet.
2. If necessary, remove access panel from the appliance to access manual shutoff valve on gas line.
3. Open access panel. Turn the manual gas shutoff valve clockwise ↻ to the full OFF position.
4. If necessary, replace Access Panel.

OPERATING INSTRUCTIONS

1. **STOP!** Read the safety information on the previous page.
2. Turn off all electric power to the appliance.
3. Do not attempt to light the pilot by hand.
4. Open access panel.
(See *Illustrated Parts List* in Owner's Manual).
5. Turn the gas control manual valve clockwise ↻ to the full OFF position.
6. Wait five (5) minutes to clear out any gas. Then smell for gas, including near the floor.
If you smell gas, **Stop!** Follow "B" in the safety information. If you don't smell gas, go to the next step.
7. Turn the gas control manual valve counterclockwise ↻ to the ON position.
8. Plug supplied 7V DC adapter into 110V power outlet.
9. Connect the wire to the DC input plug at the unit.
10. Turn on all electric power to the appliance.
11. Locate Remote Receiver inside of the unit (see *Illustrated Parts List*). Make sure that the slider switch of the Receiver is in "REMOTE" (middle) position.

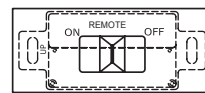

12. Close access panel.
13. Read and follow instructions in how to set up and to use remote control described in supplied "Use and Installation Instructions for the Remote Control".
14. If the appliance will not operate, follow the instructions "To Turn Off Gas To Appliance" and call your service technician or gas supplier.

CLEANING AND MAINTENANCE

INSPECTING BURNERS

Check pilot flame pattern and burner flame patterns often.

PILOT FLAME PATTERN

Figure 7 shows a correct pilot flame.

The incorrect pilot flame is not touching the flame sensor. This will cause the flame sensor to cool. When the flame sensor cools, the fireplace will shut down.



Figure 7 - Correct Pilot Flame Pattern

If pilot flame pattern is incorrect.

- turn fireplace off (see *To Turn Off Gas to Appliance*, page 23).
- see *Troubleshooting*, page 26

Note: The correct pilot flame on natural gas units will have a slight curve, but flame should be blue and have no yellow or orange color.

MAIN BURNER

Periodically inspect all burner flame holes with the heater running.

Some burner flame holes may become blocked by debris or rust, with no flame present. If so, turn off heater and let cool. Remove blockage. Blocked burner flame holes may create soot.

IMPORTANT!

If it is evident that the burner is damaged, the burner must be replaced prior to appliance being put into operation. Please refer to Illustrated Parts List when you order a replacement burner.

FRONT BURNER FLAME PATTERN

Figure 8 shows correct burner flame pattern with pattern with yellow flame tips and blue base. Figure 9 shows incorrect flame pattern. The incorrect burner flame pattern shows lazy orange flame.

If burner flame pattern is incorrect, as shown in Figure 9:

- turn fireplace off (see *To Turn Off Gas to Appliance*).
- see *Troubleshooting*, page 26.



Figure 8 - Correct Burner Flame Pattern



Figure 9 - Incorrect Burner Flame Pattern caused by port blockage

CLEANING AND MAINTENANCE

⚠ WARNING: Turn off fireplace and let cool before cleaning.

⚠ CAUTION: You must keep control areas, burner and circulating air passageways of fireplace clean. Inspect these areas of fireplace before each use. Have fireplace inspected yearly by a qualified service person. Fireplace may need more frequent cleaning due to excessive lint from carpeting, bedding material, pet hair, etc.

⚠ WARNING: Failure to keep the primary air opening of the burner clean may result in sooting and property damage.

AIR MIXER/ INJECTOR (PROPANE MODELS) AND PILOT

The primary air inlet holes allow the proper amount of air to mix with the gas. This provides a clean burning flame. Keep these holes clear of dust, dirt, lint and pet hair. Clean these air inlet holes prior to each heating season. Blocked air holes will create soot. We recommend that you clean the unit every three months during operation and have heater inspected yearly by a qualified service person.

We also recommend that you keep the burner tube and pilot assembly clean and free of dust and dirt. To clean these parts we recommend using compressed air no greater than 30 PSI. Your local computer store, hardware store or home center may carry compressed air in a can. You can use a vacuum cleaner in the blow position. If using compressed air in a can, please follow the directions on the can. If you don't follow directions on the can, you could damage the pilot assembly.

1. Shut off the unit, including the pilot. Allow the unit to cool for at least thirty minutes.
2. Check the air injector located at the end of the burner tube. Remove any large particles of dust, dirt, lint or pet hair with a soft cloth or vacuum cleaner nozzle.

3. Blow air into the primary air holes on the injector (see Figure 10).
4. In case any large clumps of dust have now been pushed into the burner repeat steps 2 and 3.

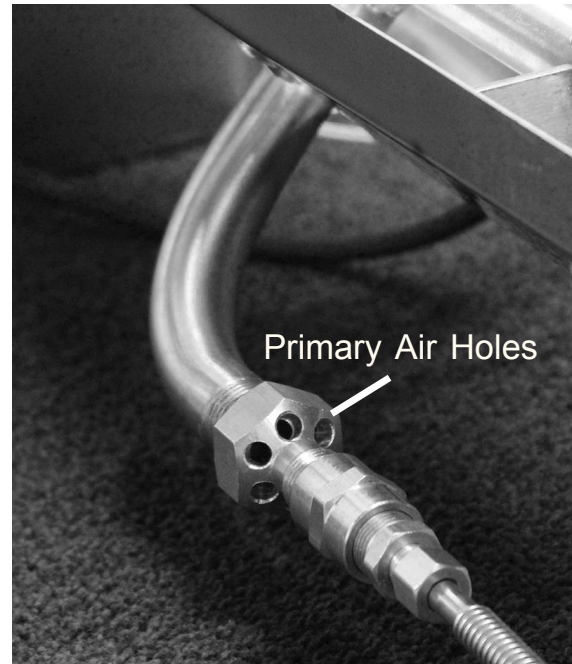

Figure 10 - Air Mixer/Injector on Burner Tube (propane models only)

Clean the pilot assembly also. A yellow tip on the pilot flame indicates dust and dirt in the pilot assembly.

IMPORTANT!

Any guard or other protective device removed for servicing the appliance shall be replaced prior to operating the appliance.

Installation and repair should be done by a qualified service person. The appliance should be inspected before use and at least annually by a qualified service person. More frequent cleaning may be required as necessary. It is imperative that the control compartment, burners, and circulating air passageways of the appliance are kept clean.

TROUBLESHOOTING

⚠ WARNING: Turn off heater and let cool before servicing. Only a qualified service person should service and repair heater.

⚠ CAUTION: Never use a wire, needle or similar object to clean ODS/pilot. This can damage ODS/pilot unit.

Note: All troubleshooting items are listed in order of operation.

OBSERVED PROBLEM	POSSIBLE CAUSE	REMEDY
When remote button is pressed, there is no spark at pilot	<ol style="list-style-type: none"> Ignitor electrode not connected to ignitor cable Ignitor cable pinched or wet Broken ignitor cable Bad ignitor Ignitor electrode broken Ignitor electrode positioned wrong Low batteries. 	<ol style="list-style-type: none"> Reconnect ignitor cable Free ignitor cable if pinched by any metal or tubing. Keep ignitor cable dry Replace ignitor cable Call for service Replace pilot assembly Replace pilot assembly Replace batteries in remote control and receiver, re-program the receiver.
When remote button is pressed, there is spark at pilot but no ignition	<ol style="list-style-type: none"> Gas supply turned off or equipment shutoff valve closed Air in gas lines when installed Depleted gas supply Pilot is clogged Gas regulator setting is not correct 	<ol style="list-style-type: none"> Turn on gas supply or open equipment shutoff valve Repeat igniting operation until air is removed. Contact local gas company Clean pilot (see Cleaning and Maintenance, page 25) or replace pilot assembly Replace gas control

OBSERVED PROBLEM	POSSIBLE CAUSE	REMEDY
Pilot lights but flame goes out	<ol style="list-style-type: none"> 1. Equipment shutoff valve not fully open 2. Pilot flame not touching flame sensor, which allows flame sensor to cool, causing pilot flame to go out. This problem could be caused by one or both of the following: <ol style="list-style-type: none"> A) Low gas pressure B) Dirty or partially clogged pilot 3. Flame sensor connection loose at control valve 4. Flame sensor damaged 5. Control valve damaged 6. Safety interlock system has been triggered 7. Flame sensor dirty 8. Faulty DFC module. 	<ol style="list-style-type: none"> 1. Fully open equipment shut-off valve 2. A) Contact local gas company B) Clean pilot (see Cleaning and Maintenance, page 25) or replace pilot assembly 3. Hand tighten until snug, then tighten 1/4 turn more 4. Replace pilot assembly 5. Replace control valve 6. Wait one minute for safety interlock system to reset. Repeat ignition operation. 7. Clean sensor 8. Replace module
Burner does not light after pilot is lit	<ol style="list-style-type: none"> 1. Inlet gas pressure is too low 2. Burner orifice clogged 3. Burners will not come on in remote position 4. Wire disconnected from gas control 	<ol style="list-style-type: none"> 1. Contact local natural or propane gas company 2. Clean burner (see Cleaning and Maintenance, page 24) or replace burner orifice 3. Replace battery in transmitter and receiver 4. Reconnect wire (see Wiring Diagram, page 30)
Delayed ignition of burner	<ol style="list-style-type: none"> 1. Manifold pressure is too low 2. Burner orifice clogged 3. Dirty pilot 4. Too much media around pilot area. 	<ol style="list-style-type: none"> 1. Contact local natural or propane gas company 2. Clean burner (see Cleaning and Maintenance, page 24) or replace burner orifice 3. Check if pilot has proper flame, clean the pilot. 4. Clear area in front of pilot assembly, make sure pilot flame is positioned correctly

TROUBLESHOOTING *Continued*

OBSERVED PROBLEM	POSSIBLE CAUSE	REMEDY
Burner backfiring during combustion	<ol style="list-style-type: none">1. Burner orifice is clogged or damaged2. Damaged burner3. Gas regulator defective	<ol style="list-style-type: none">1. Clean burner (see Cleaning and Maintenance, page 23) or replace burner orifice2. Replace damaged burner3. Replace gas regulator
Slight smoke or odor during initial operation	<ol style="list-style-type: none">1. Residues from manufacturing processes2. Not enough air3. Gas regulator defective	<ol style="list-style-type: none">1. Problem will stop after a few hours of operation2. Check burner for dirt and debris. If found, clean burner (see Cleaning and Maintenance, page 23)3. Replace gas control
Heater produces a whistling noise when burner is lit	<ol style="list-style-type: none">1. Air in gas line2. Air passageways on heater blocked3. Dirty or partially clogged burner orifice4. Restricted gas flow through flex connector	<ol style="list-style-type: none">1. Operate burners until air is removed from line. Have gas line checked by local natural or propane gas company2. Observe minimum installation clearances (see page 10)3. Clean burner (see Cleaning and Maintenance, page 23) or replace burner orifice4. Check and adjust flex connector position to eliminate possible kinks.
Remote does not function	<ol style="list-style-type: none">1. Remote receiver "locked".2. Battery is not installed. Battery power is low.	<ol style="list-style-type: none">1. See instructions supplied with Remote Control2. Replace batteries in receiver and remote control, re-program remote control.

⚠ WARNING: If you smell gas

- **Shut off gas supply.**
- **Do not try to light any appliance.**
- **Do not touch any electrical switch; do not use any phone in your building.**
- **Immediately call your gas supplier from a neighbor's phone. Follow the gas supplier's instructions.**
- **If you cannot reach your gas supplier, call the fire department.**

IMPORTANT: Operating fireplace where impurities in air exist may create odors. Cleaning supplies, paint, paint remover, cigarette smoke, cements and glues, new carpet or textiles, etc., create fumes. These fumes may mix with combustion air and create odors. These odors will disappear over time.

OBSERVED PROBLEM	POSSIBLE CAUSE	REMEDY
-------------------------	-----------------------	---------------

Fireplace produces a clicking/ticking noise just after burners are lit or shut off

1. Metal expanding while heating or contracting while cooling

1. This is common with most fireplaces. If noise is excessive, contact qualified service person

Fireplace produces unwanted odors

1. Low fuel supply (propane gas only)
2. Gas leak. See Warning statement above.

1. Refill supply tank (propane gas only)
2. Locate and correct all leaks (see Checking Gas Connections, page 18)

Gas odor even when control knob is in OFF position

1. Gas leak.

2. Control valve or gas control defective

1. Locate and correct all leaks.

2. Replace control valve or gas control

Proflame Wiring Diagram

This diagram shows replaceable SIT Proflame parts used in your fireplace (please, refer to pages 31-35).

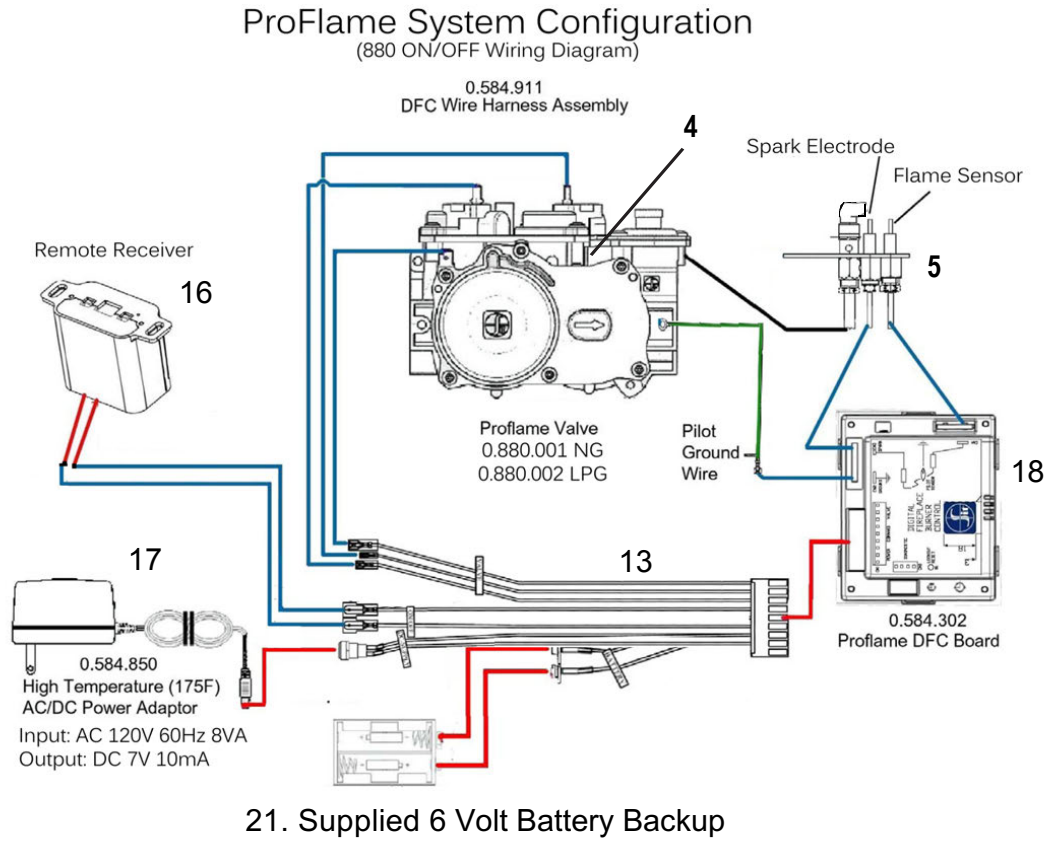

ILLUSTRATED PARTS BREAKDOWN

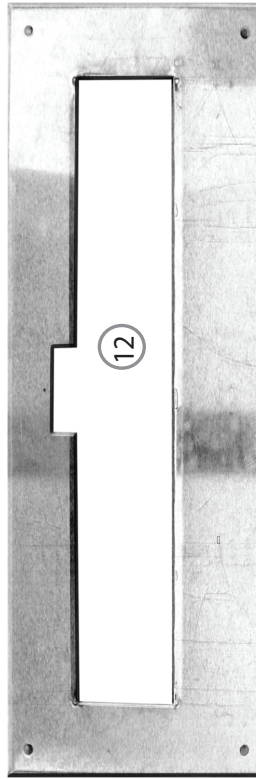
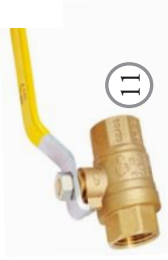
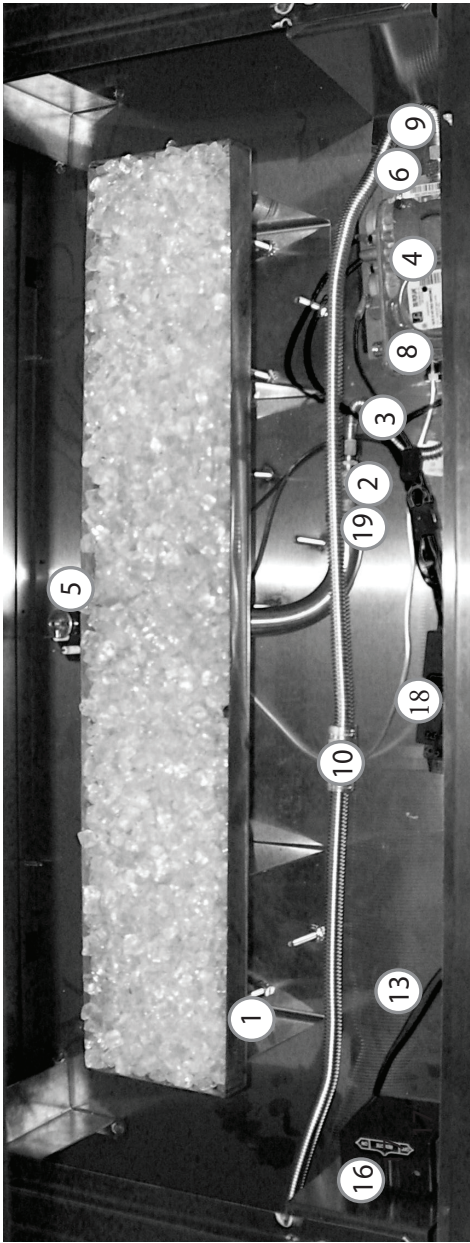

PARTS LIST

This list contains replaceable parts used in your firebox.

All replacement parts should be ordered from your installer or from Woodbridge Fireplace Inc.

at 1-905-564-3001 or on-line at www.woodbridgedealer.com

KEY NO.	PART NUMBER		DESCRIPTION	QTY
	S V- 3 6 N	S V- 3 6 P		
1	W700003	W700003	BURNER ASSEMBLY	1
2	F300036	F300037	BURNER ORIFICE	1
3	C100039	C100039	TS-12 BURNER FLEX CONNECTOR	1
4	R100026	R100027	MAIN GAS VALVE	1
5	R100028-SS	R100029-SS	PILOT ASSEMBLY	1
6	F200022-SS	F200022-SS	GAS VALVE MOUNT BRACKET	2
7	F200033-SS	F200033-SS	PILOT SCREEN	1
8	F200100	N/A	3/8"NPS X 5/16" COMP. FITTING	1
9	H100066	H100066	3/8"NPS X 1/2" FLARE FITTING	1
10	C100072	C100072	1/2" X 18" FLEX. CONNECTOR	1
11	D300090	D300090	SUPPLIED 1/2" SHUTOFF VALVE	1
12	W200032	W200032	MEDIA TRAY	1
13	H200012	H200012	WIRE HARNESS	1
14	C100020-A	C100020-A	DUPLEX POWER OUTLET (not shown)	1
15	PCB	PCB	SKYTECH REMOTE CONTROL	1
16	PCB-R	PCB-R	SKYTECH REMOTE RECEIVER	1
17	H100140	H100140	7V AC/DC POWER ADAPTER	1
18	H100142	H100142	S.I.T. DFC CONTROL BOARD	1
19	C100041	N/A	1/2" NPT X3/8" NPT BRASS COUPLING	1
20	F200031	F200031	DFC MODULE COVER (not shown)	1
21	H100139	H100139	6 Volt BATTERY PACK	1
22	A100040	A100040	GLASS FRAME DOOR ASSEMBLY	1
23	F200029-30	F200029-30	GLASS BRACKET ASSEMBLY	2
24	W300015	W300015	SAFETY SCREEN INDOOR SIDE	1
25	G100003	G100003	CERAMIC GLASS WIND BAFFLE	1
ACCESSORIES AVAILABLE (NOT SHOWN)				
	XXXXXXX	XXXXXXX	VARIOUS MEDIA FOR TRAY	1

PARTS LIST

This list contains replaceable parts used in your firebox.

All replacement parts should be ordered from your installer or from Woodbridge Fireplace Inc.
at 1-905-564-3001 or on-line at www.woodbridgedealer.com

KEY NO.	PART NUMBER		DESCRIPTION	QTY
	S V- 48 N	S V- 48 P		
1	W700005	W700005	BURNER ASSEMBLY	1
2	F300048	F300049	BURNER ORIFICE	1
3	C100039	C100039	TS-12 BURNER FLEX CONNECTOR	1
4	R100026	R100027	MAIN GAS VALVE	1
5	R100028-SS	R100029-SS	PILOT ASSEMBLY	1
6	F200022-SS	F200022-SS	GAS VALVE MOUNT BRACKET	2
7	F200033-SS	F200033-SS	PILOT SCREEN	1
8	F200100	N/A	3/8"NPS X 5/16" COMP. FITTING	1
9	H100066	H100066	3/8"NPS X 1/2" FLARE FITTING	1
10	C100072	C100072	1/2" X 18" FLEX. CONNECTOR	1
11	D300090	D300090	SUPPLIED 1/2" SHUTOFF VALVE	1
12	W200034	W200034	MEDIA TRAY	1
13	H200012	H200012	WIRE HARNESS	1
14	C100020-A	C100020-A	DUPLEX POWER OUTLET (not shown)	1
15	PCB	PCB	SKYTECH REMOTE CONTROL	1
16	PCB-R	PCB-R	SKYTECH REMOTE RECEIVER	1
17	H100140	H100140	7V AC/DC POWER ADAPTER	1
18	H100142	H100142	S.I.T. DFC CONTROL BOARD	1
19	C100041	N/A	1/2" NPT X3/8" NPT BRASS COUPLING	1
20	F200031	F200031	DFC MODULE COVER (not shown)	1
21	H100139	H100139	6 Volt BATTERY PACK	1
22	A100041	A100041	GLASS FRAME DOOR ASSEMBLY	1
23	F200029-30	F200029-30	GLASS BRACKET ASSEMBLY	2
24	W300016	W300016	SAFETY SCREEN INDOOR SIDE	1
25	G100004	G100004	CREAMIC GLASS WIND BAFFLE	1
ACCESSORIES AVAILABLE (NOT SHOWN)				
	XXXXXXX	XXXXXXX	VARIOUS MEDIA FOR TRAY	1

PARTS LIST

This list contains replaceable parts used in your firebox.

All replacement parts should be ordered from your installer or from Woodbridge Fireplace Inc.

at 1-905-564-3001 or on-line at www.woodbridgedealer.com

KEY NO.	PART NUMBER		DESCRIPTION	QTY
	S V - 6 0 N	S V - 6 0 P		
1	W700007	W700007	BURNER ASSEMBLY	1
2	F300060	F300061	BURNER ORIFICE	2
3	C100009	C100009	3/8" x 24" FLEX CONNECTOR	2
4	R100026	R100027	MAIN GAS VALVE	1
5	R100028-SS	R100029-SS	PILOT ASSEMBLY	1
6	F200022-SS	F200022-SS	GAS VALVE MOUNT BRACKET	2
7	F200033-SS	F200033-SS	PILOT SCREEN	1
8	C100010	C100010	3/8" X 18" FLEX CONNECTOR	1
9	C100083	C100083	3/8"NPS X 1/2" FLARE 90 DEG. FITTING	1
10	C100080	C100080	1/2" X 48" FLEX. CONNECTOR	1
11	D300090	D300090	SUPPLIED 1/2" SHUTOFF VALVE	1
12	W200060	W200060	MEDIA TRAY	1
13	H200012	H200012	WIRE HARNESS	1
14	C100020-A	C100020-A	DUPLEX POWER OUTLET (not shown)	1
15	PCB	PCB	SKYTECH REMOTE CONTROL	1
16	PCB-R	PCB-R	SKYTECH REMOTE RECEIVER	1
17	H100140	H100140	7V AC/DC POWER ADAPTER	1
18	H100142	H100142	S.I.T. DFC CONTROL BOARD	1
19	C100041	N/A	1/2" NPT X3/8" NPT BRASS COUPLING	2
20	F200031	F200031	DFC MODULE COVER (not shown)	1
21	H100139	H100139	6 Volt BATTERY PACK	1
22	A100042	A100042	GLASS FRAME DOOR ASSEMBLY	1
23	F200029-30	F200029-30	GLASS BRACKET ASSEMBLY	4
24	W3000017	W300017	SAFETY SCREEN INDOOR SIDE	1
25	G100005	G100005	CREAMIC GLASS WIND BAFFLE	1
ACCESSORIES AVAILABLE (NOT SHOWN)				
	XXXXXXXX	XXXXXXXX	VARIOUS MEDIA FOR TRAY	1

PARTS LIST

This list contains replaceable parts used in your firebox.

All replacement parts should be ordered from your installer or from Woodbridge Fireplace Inc.

at 1-905-564-3001 or on-line at www.woodbridgedealer.com

KEY NO.	PART NUMBER		DESCRIPTION	QTY
	SV - 7 2 N	SV - 7 2 P		
1	W700006	W700006	BURNER ASSEMBLY	1
2	F300072	F300073	BURNER ORIFICE	2
3	D300098	D300098	1/2" x 12" FLEX CONNECTOR	1
4	R100026	R100027	MAIN GAS VALVE	1
5	R100028-SS	R100029-SS	VENT-FREE PILOT ASSEMBLY	1
6	F200022-SS	F200022-SS	GAS VALVE MOUNT BRACKET	2
7	F200033-SS	F200033-SS	PILOT SCREEN	1
8	C100072	C100072	1/2" X 18" FLEX CONNECTOR	1
9	C100083	C100083	3/8"NPS X 1/2" FLARE 90 DEG. FITTING	1
10	C100080	C100080	1/2" X 48" FLEX. CONNECTOR	2
11	D300090	D300090	SUPPLIED 1/2" SHUTOFF VALVE	1
12	W200059	W200059	MEDIA TRAY	1
13	H200012	H200012	WIRE HARNESS	1
14	C100020-A	C100020-A	DUPLEX POWER OUTLET (not shown)	1
15	PCB	PCB	SKYTECH REMOTE CONTROL	1
16	PCB-R	PCB-R	SKYTECH REMOTE RECEIVER	1
17	H100140	H100140	7V AC/DC POWER ADAPTER	1
18	H100142	H100142	S.I.T. DFC CONTROL BOARD	1
19	C100041	N/A	1/2" NPT X3/8" NPT BRASS COUPLING	2
20	F200031	F200031	DFC MODULE COVER (not shown)	1
21	H100139	H100139	6 Volt BATTERY PACK	1
-	H100087	H100087	3/8" NPT FEM. TO MALE 90 ELBOW	1
-	H100066	H100066	3/8" NPT X 1/2" FLARE COUPLER	1
-	H100088	H100088	1/2" FLARE BRASS TEE	1
-	H100089	H100089	1/2" FLARE x 3/8" NPT FEM. COUPLER	1
22	A100043	A100043	GLASS FRAME DOOR ASSEMBLY	1
23	F200029-30	F200029-30	GLASS BRACKET ASSEMBLY	4
24	W300018	W300018	SAFETY SCREEN INDOOR SIDE	1
25	G100006	G100006	CERAMIC GLASS WIND BAFFLE	1
ACCESSORIES AVAILABLE (NOT SHOWN)				
	XXXXXXX	XXXXXXX	VARIOUS MEDIA FOR TRAY	1



LIFETIME WARRANTY

The following components are warranted for life to the original owner, subject to proof of purchase: Firebox, Combustion Chamber, and Steel Burners.

BASIC WARRANTY

Woodbridge Fireplace Inc. warrants the components and materials in your gas appliance to be free from manufacturing and material defects for a period of two years from date of installation. After installation, if any of the components manufactured by Woodbridge Fireplace Inc. in the appliance are found to be defective in materials or workmanship, Woodbridge Fireplace Inc. will, at its option, replace or repair the defective components at no charge to the original owner. Woodbridge Fireplace Inc. will also pay for reasonable labor costs incurred in replacing or repairing such components for a period of two years from date of installation. Any products presented for warranty repair must be accompanied by a dated proof of purchase.

This Limited Lifetime Warranty will be void if the appliance is not installed by a qualified installer in accordance with the installation instructions. The Limited Lifetime Warranty will also be void if the appliance is not operated and maintained according to the operating instructions supplied with the appliance, and does not extend to (1) firebox/burner assembly damage by accident, neglect, misuse, abuse, alterations, negligence of others, including the installation thereof by unqualified installers, (2) the costs of removal, reinstallation or transportation of defective parts on the appliance, or (3) incidental or consequential damage. All service work must be performed by an authorized service representative.

This warranty is expressly in lieu of other warranties, express or implied, including the warranty of merchantability of fitness for purpose and of all other obligations or liabilities. Woodbridge Fireplace Inc. does not assume for it any other obligations or liabilities in connection with sale or use of the appliance. It states that do not allow limitations on how long an implied warranty lasts, or do not allow exclusion of indirect damage, those limitations of exclusions may not apply to you. You may also have additional rights not covered in the Limited Lifetime Warranty.

Woodbridge Fireplace Inc. reserves the right to investigate any and all the claims against the Limited Lifetime Warranty and decide upon method of settlement.

For information about this warranty, contact:

Woodbridge Fireplace Inc.
1305 Meyerside Dr., Mississauga
Ontario, Canada L5T 1C9
Tel.: 1-905-564-3001
www.woodbridgedealer.com